

WAR DEPARTMENT TECHNICAL MANUAL

TM 9-394

This TM supersedes WDTB 9-393-1, dated 15 May 44; WDTB 9-394-1, dated 2 Feb 45; and WDTB ORD 121, dated 12 Jul 44. This TM supersedes portions of WDTB ORD 236, dated 21 Dec 44, which apply to the materiel covered in this TM; however, this TB remains in force until incorporated in other affected TM's or specifically rescinded.

---

4.5-INCH  
ROCKET MATERIEL  
FOR GROUND USE



WAR DEPARTMENT

• 7 FEBRUARY 1945

---

**RESTRICTED. DISSEMINATION OF RESTRICTED MATTER.**

No person is entitled solely by virtue of his grade or position to knowledge or possession of classified matter. Such matter is entrusted only to those individuals whose official duties require such knowledge or possession.

(See also paragraph 23b, AR 380-5, 15 March 1944.)

---

WAR DEPARTMENT

Washington 25, D. C., 7 February 1945

TM 9-394, 4.5-inch Rocket Materiel for Ground Use, is published for the information and guidance of all concerned.

[ A.G. 300.7 (3 Jan 45)  
O.O. 300.7/2978 ]

BY ORDER OF THE SECRETARY OF WAR:

G. C. MARSHALL,  
*Chief of Staff.*

OFFICIAL:

J. A. ULIO,  
*Major General,  
The Adjutant General.*

DISTRIBUTION: AAF (10); AGF (10); ASF (2); S Div ASF (1); AAF Comds (2); Arm & Sv Bd (2); Dept (10); Tech Sv (2); Sv C (10); PC&S (1); PE "Mark for Ord O" (5); H&R (5); Dist O, 9 (5); Dist Br O, 9 (3); Reg O, 9 (3); Establishments, 9 (5); Decentralized Sub-O, 9 (3); Gen & Sp Sv Sch (10); USMA (2); A (10); CHQ (10); D (2); AF (2); T/O & E 9-7 (3); 9-9 (3); 9-37 (3); 9-57 (3); 9-65 (2); 9-67 (3); 9-76 (2); 9-127 (3); 9-197 (3); 9-317 (3); 9-325 (2); 9-327 (3); 9-328 (3); 9-377 (3).

(For explanation of symbols, see FM 21-6.)

# CONTENTS

## PART ONE—INTRODUCTION

SECTION		Paragraphs	Pages
	I. General .....	1- 2	1- 2
	II. Description and data.....	3-11	2-16

## PART TWO—OPERATING INSTRUCTIONS

SECTION	III. General .....	12	17
	IV. Service upon receipt of equipment .....	13-19	17-19
	V. Controls for launchers M12, M12A1, and M12E2.....	20-21	19-20
	VI. Controls and instruments for launchers T27 and T27E1..	22-23	20-22
	VII. Controls and instruments for launchers T34 and T34E1..	24-25	23-25
	VIII. Controls and instruments for launcher T44 .....	26-27	26-27
	IX. Controls and instruments for launcher T45 .....	28-29	27-29
	X. Operation of launchers M12, M12A1, and M12E2 under usual conditions .....	30-35	29-38
	XI. Operation of launchers T27 and T27E1 under usual conditions .....	36-41	38-48
	XII. Operation of launchers T34 and T34E1 under usual conditions .....	42-46	49-54
	XIII. Operation of launcher T44 under usual conditions.....	47-52	55-58
	XIV. Operation of launcher T45 under usual conditions.....	53-59	58-64
	XV. Operation under unusual con- ditions .....	60-64	65-66
	XVI. Demolition to prevent enemy use .....	65-70	66-67

# CONTENTS (Contd.)

## PART THREE—MAINTENANCE INSTRUCTIONS

	Paragraphs	Pages
SECTION XVII. General .....	71	68
XXVIII. Preventive maintenance service .....	72	68- 69
XXIX. Preventive maintenance schedules .....	73- 77	69- 71
XX. Malfunctions and corrections..	78- 83	71- 74
XXI. Groups comprising launchers M12, M12A1, and M12E2..	84- 88	74- 79
XXII. Groups comprising launchers T27 and T27E1.....	89- 94	79- 84
XXIII. Groups comprising launchers T34 and T34E1.....	95-100	84- 88
XXIV. Groups comprising launcher T44 when mounted in 2½-ton, 6 x 6, amphibian truck, GMC, DUKW-353 .....	101-106	88- 93
XXV. Groups comprising launcher T44 when mounted in landing vehicle, tracked (A) (4)	107	93- 94
XXVI. Groups comprising launcher T45 .....	108-115	94-100

## PART FOUR—AUXILIARY EQUIPMENT

SECTION XXVII. General .....	116	101
XXVIII. Ammunition .....	117-129	101-123
XXIX. Fire control equipment for the 4.5-inch multiple rocket launchers T27, T27E1, and the 4.5-inch automatic rocket launcher T45 .....	130-133	123-128

## APPENDIX

SECTION XXX. Storage and shipment.....	134-136	129-130
XXXI. References .....	137-139	131-132
INDEX .....		133-136



**RESTRICTED**

This TM supersedes WDTB 9-393-1, dated 15 May 44; WDTB 9-394-1, dated 2 Feb 45; and WDTB ORD 121, dated 12 Jul 44. This TM supersedes portions of WDTB ORD 236, dated 21 Dec 44, which apply to the materiel covered in this TM; however, this TB remains in force until incorporated in other affected TM's or specifically rescinded.

**PART ONE—INTRODUCTION****Section I****GENERAL****1. SCOPE.\***

a. This manual is published for the information of the using arms and services.

b. In addition to a description of the 4.5-inch rocket materiel listed below this manual contains technical information required for the identification, use, and care of the materiel, ammunition, and accessory equipment.

c. In all cases where the nature of the repair, modification, or adjustment is beyond the scope or facilities of the unit, the responsible ordnance service should be informed so that trained personnel with suitable tools and equipment may be provided, or proper instructions issued.

**(1) LAUNCHERS.**

- (a) Launcher, rocket, 4.5-inch, M12
- (b) Launcher, rocket, 4.5-inch, M12A1
- (c) Launcher, rocket, 4.5-inch, M12E2
- (d) Launcher, rocket, multiple, 4.5-inch, T27
- (e) Launcher, rocket, multiple, 4.5-inch, T27E1
- (f) Launcher, rocket, 4.5-inch, T34
- (g) Launcher, rocket, 4.5-inch, T34E1
- (h) Launcher, rocket, multiple, 4.5-inch, T44
- (i) Launcher, rocket, automatic, 4.5-inch, T45

**(2) ROCKETS.**

- (a) Rockets, M8, M8A1, M8A2, and M8A3
- (b) Rockets, M9, M9A1, M9A2, and M9A3
- (c) Rocket, T22
- (d) Rocket, T46
- (e) Rockets, T38E3 and T38E7
- (f) Rockets, T39E3 and T39E7
- (g) Rocket, HE, beach barrage, 4.5-inch (Navy)
- (h) Rocket, smoke, WP, 4.5-inch (Navy)

**(3) FUZES.**

- (a) Fuzes, M4, M4A1, and M4A2
- (b) Fuze, M6

\*To provide operating instructions with the materiel, this Technical Manual has been published in advance of complete technical review. Any errors or omissions will be corrected by changes or, if extensive, by an early revision.

## TM 9-394

1-4

### 4.5-INCH ROCKET MATERIEL FOR GROUND USE

- (c) Fuze, PD, M81 (for T38E7 round)
- (d) Fuze, dummy, M73 (for T39E7 round)

#### 2. RECORDS.

a. **Field Report of Accidents.** When an accident involving ammunition occurs during practice, the incident will be reported as prescribed in AR 750-10 by the ordnance officer under whose supervision the ammunition is maintained or issued. Where practicable, reports covering malfunctions of ammunition in combat will be made to the Chief of Ordnance, giving the type of malfunction, type of ammunition, the lot number of the complete rounds or separate loading components, and condition under which fired.

b. **Unsatisfactory Equipment Report.** Suggestions for improvement in design, maintenance, safety, and efficiency of operation prompted by chronic failure or malfunction of the weapon, spare parts, or equipment should be reported on WD AGO Form No. 468, Unsatisfactory Equipment Report, with all pertinent information necessary to initiate corrective action. The report should be forwarded to the Office, Chief of Ordnance, Field Service, Maintenance Division, through Command Channels in accordance with instruction No. 7 on the form. Such suggestions are encouraged in order that other organizations may benefit.

---

#### Section II

### DESCRIPTION AND DATA

#### 3. 4.5-INCH ROCKET LAUNCHER M12 (fig. 1).

a. The 4.5-inch Rocket Launcher M12 is a smooth-bore plastic tube, 4 feet long, which is used to launch the 4.5-inch HE Rocket M8. The launcher tube is issued with a tripod mount and a fuze rocket in place ready to be fired electrically except for some preliminary preparations as described in paragraph 30. This weapon can be accurately fired only at short ranges. Both launcher tube and tripod have been designed for lightness and portability and should be used for the one round packed in the launcher tube. After the rocket is fired, the launcher tube and tripod should be discarded.

#### 4. 4.5-INCH ROCKET LAUNCHERS M12A1 AND M12E2 (fig. 2).

a. This model differs from the M12 in that it is issued with an unfuzed 4.5-inch HE Rocket T38E7 and the front spacer is approximately 2 inches longer to compensate for the difference in the length

**DESCRIPTION AND DATA**

of the rocket. The front spacer contains the fuze in a fiber container. The Launcher M12E2 differs from the M12A1 only in that the tube is of magnesium alloy instead of plastic.

**5. 4.5-INCH MULTIPLE ROCKET LAUNCHER T27 (figs. 3 and 4).**

a. The Multiple Rocket Launcher T27 consists of a mount of welded tubular construction and eight launcher tubes for discharging 4.5-inch rockets. It may be fired when mounted in a motor vehicle or from the ground. It is provided with an elevation control, but no provision is made for movement in azimuth. It has an electrical firing control for discharging the rockets.

**6. 4.5-INCH MULTIPLE ROCKET LAUNCHER T27E1.**

a. This model differs from the T27 in that it can be broken down into two-man loads in order to facilitate assembly of the launcher preparatory to firing from the ground.

**7. 4.5-INCH ROCKET LAUNCHER T34 (fig. 5).**

a. The Rocket Launcher T34 may be mounted on the Medium Tank M4, M4A1, M4A2, M4A3, M4A4, or M4A6. Its use permits the tank to discharge sixty 4.5-inch HE rockets without reloading. The launcher is constructed so that it is controlled in elevation and azimuth with the same controls used for the 75-mm gun in the turret. The rockets are discharged electrically and the entire launcher may be jettisoned at will by means of hydraulic controls within the turret.

b. The principal part of the launcher is the group of sixty fiber tubes from which the rockets are launched. These tubes are 90 inches long. An elevating strut connects the forward end of the tube group with the 75-mm gun tube. Due to this type of connection the 75-mm gun should not be fired as long as the launcher is mounted on the tank.

**8. 4.5-INCH ROCKET LAUNCHER T34E1 (fig. 6).**

a. This model is identical with the Launcher T34 except that the tubes are made of magnesium and the elevating strut extends from the launcher to an adapter on the 75-mm gun shield, permitting the use of the 75-mm gun while the launcher is mounted. In addition it has a periscope block which joins the cables from the inside of the tank to those on the outside and permits them to separate automatically when the launcher is jettisoned.

**9. 4.5-INCH MULTIPLE ROCKET LAUNCHER T44 (fig. 7).**

a. The 4.5-inch Multiple Rocket Launcher T44 is a 120-tube launcher issued for installation in the cargo space of the 2½-ton,

**4.5-INCH ROCKET MATERIEL FOR GROUND USE**

6 x 6, amphibian truck, GMC, DUKW-353. However, the launcher can be installed in the cargo space of the Landing Vehicle, tracked (armored), Mk. IV. The launcher has an electric firing system, controlled by the co-driver, which uses current from the vehicle ignition system and which can fire 120 4.5-inch beach barrage HE rockets in either ripple or single action fire.

**10. 4.5-INCH AUTOMATIC ROCKET LAUNCHER T45 (figs. 8, 9, and 10).**

a. The 4.5-inch Automatic Rocket Launcher T45 is issued for installation on LVT's, in trucks or other similar types of installations. It can, however, be fired from the ground. This launcher feeds automatically by gravity and fires 12 Navy 4.5-inch beach barrage HE rockets, either singly or in ripple fire, with one loading. A battery of these launchers may be emplaced side by side or separated over a convenient area, electrically wired together and controlled from one firing point. Electric power for firing may be obtained from the vehicle ignition system, from a storage battery, dry cell battery, or a generator which produces from six to eight volts. The elevation of the launcher is adjustable but there is no provision for mechanical traversing.

**11. TABULATED DATA.**

**a. 4.5-inch Rocket Launchers M12, M12A1, and M12E2.**

	M12	M12A1	M12E2
Weight of launcher (lb).....	22	22	22
Weight of rocket and launcher as issued (approx) (lb).....	60	64	64
Weight of rocket, launcher, and pack board (lb).....	64	68	68
Over-all length (ft).....	4	4	4
Type of sights.....	White line painted on launcher tube, front and rear open sights, or folding rear peep sight and a fixed front stud.		
Diameter of tube (in.).....	4.5	4.5	4.5
Material of tube.....	Plastic	Plastic	Mg. Alloy
Type of firing mechanism.....	Battery or 10-cap exploder	Battery or 10-cap exploder	Battery or 10-cap exploder
Weight of 10-cap exploder (lb)....	5	5	5
Rockets authorized.....	Army Fin type	Spin type	Spin type

DESCRIPTION AND DATA

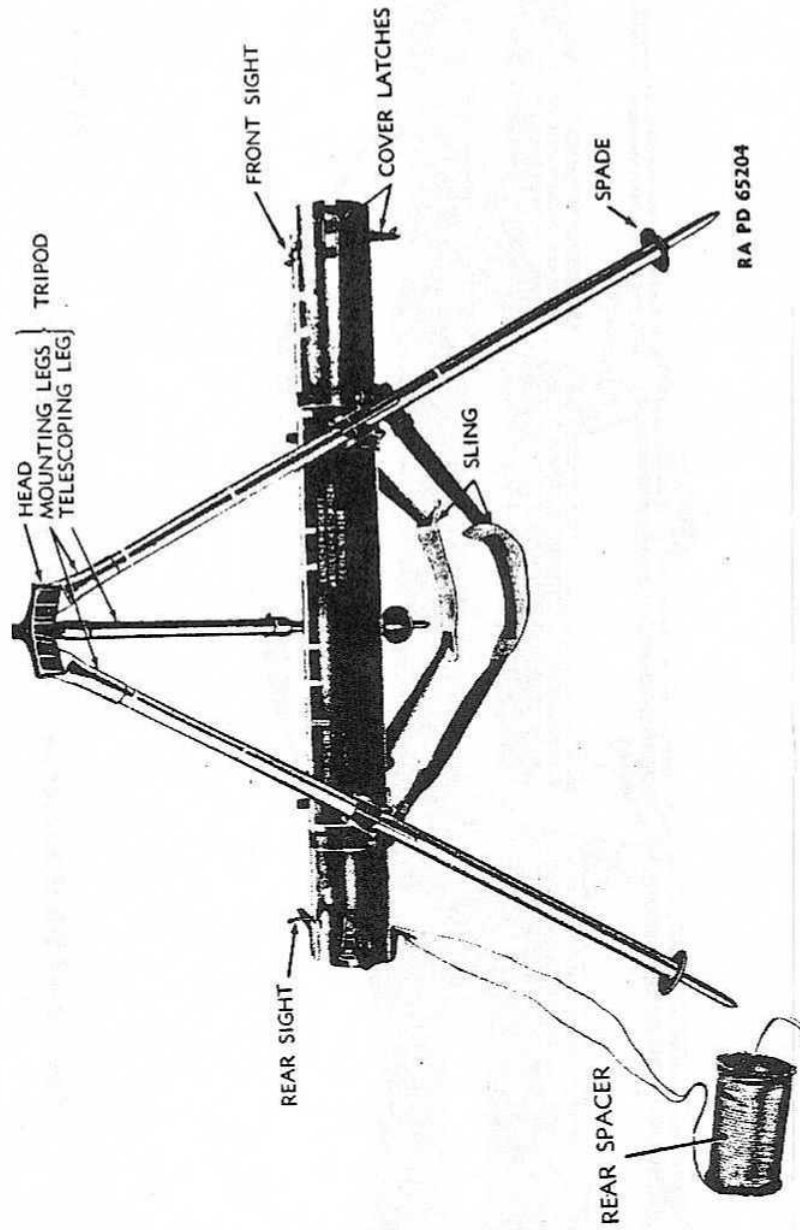
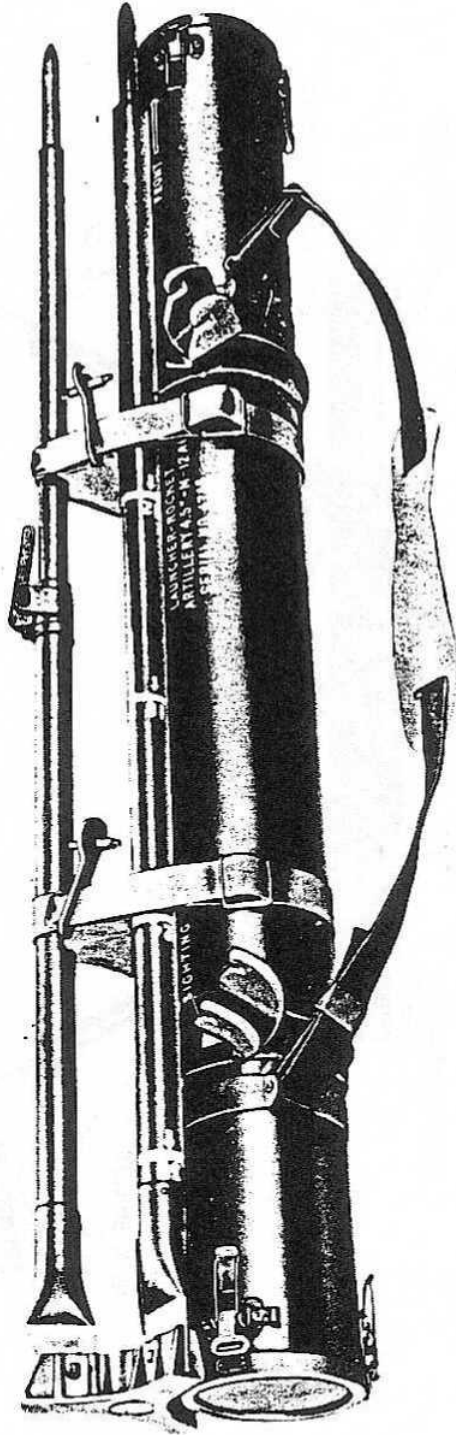

Figure 1—4.5-inch Rocket Launcher M12—Assembled

TM 9-394

11

4.5-INCH ROCKET MATERIEL FOR GROUND USE



RA PD 65202

Figure 2—4.5-inch Rocket Launcher M12A1 and M12E2—as Issued

DESCRIPTION AND DATA

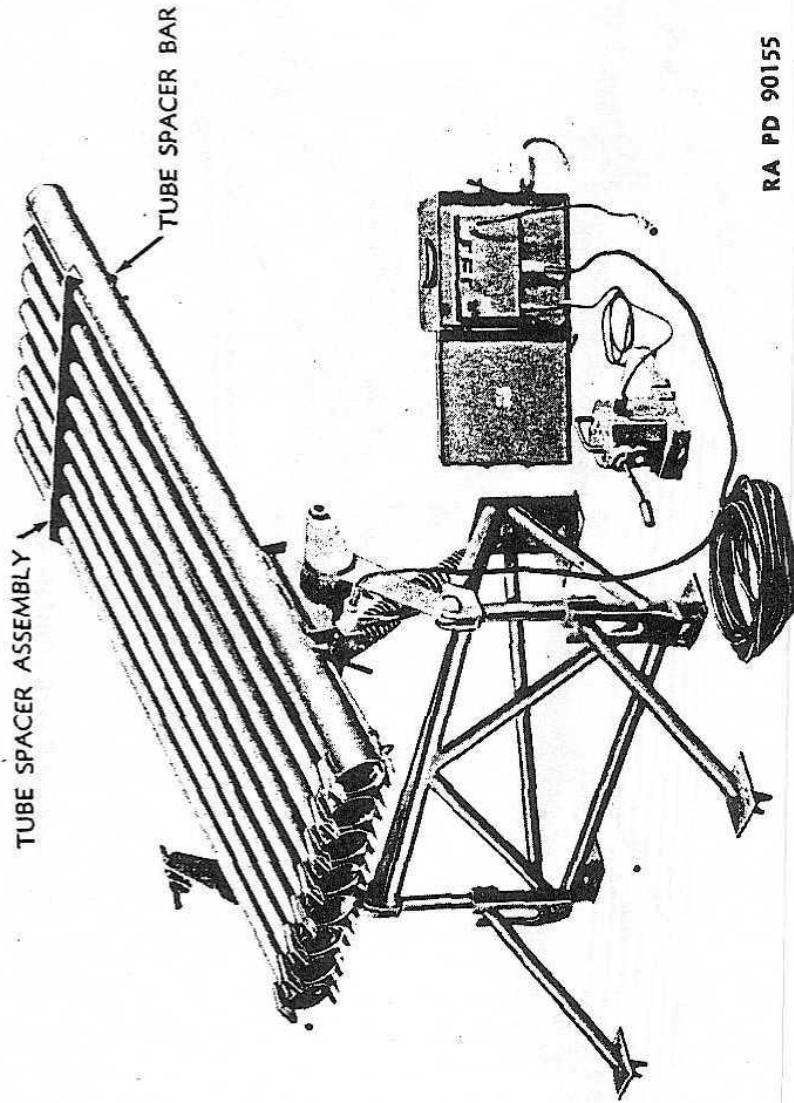

RA PD 90155

Figure 3—4.5-inch Multiple Rocket Launcher T27 With Firing Control and Generator

TM 9-394  
11

4.5-INCH ROCKET MATERIEL FOR GROUND USE

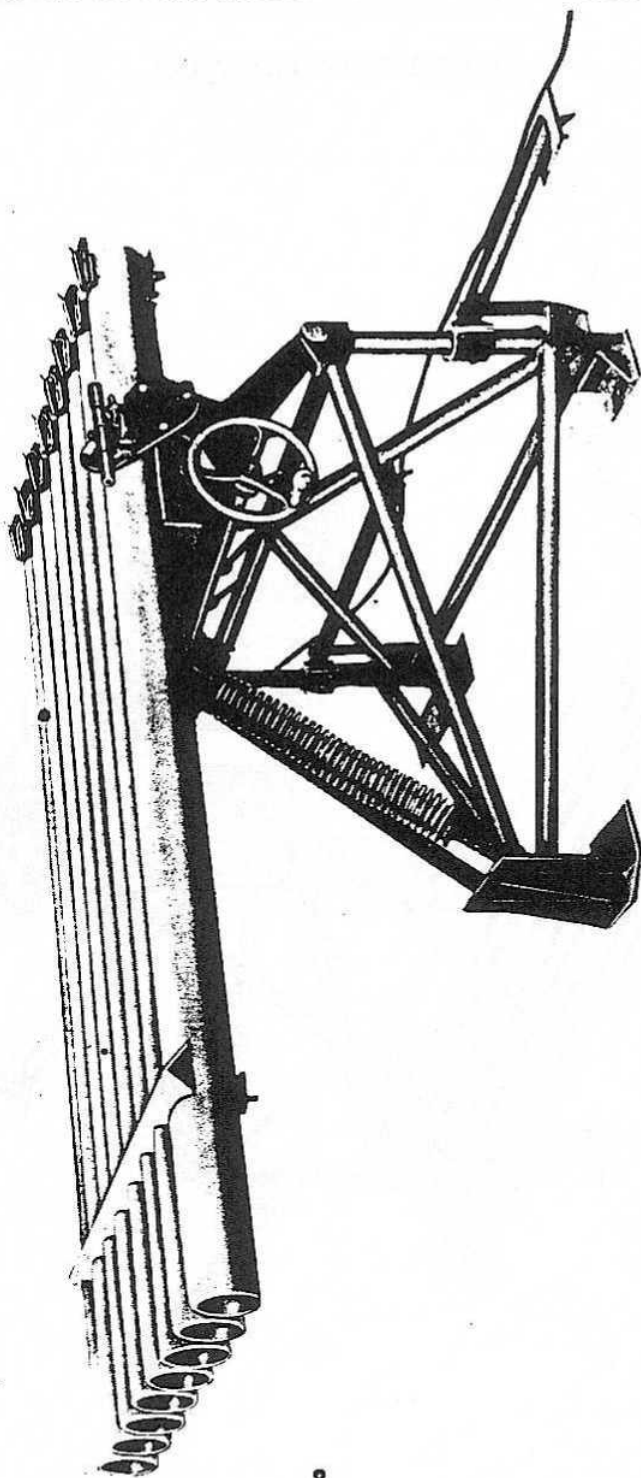

RA PD 90135

Figure 4—4.5-inch Multiple Rocket Launcher T27—Left Side View



DESCRIPTION AND DATA

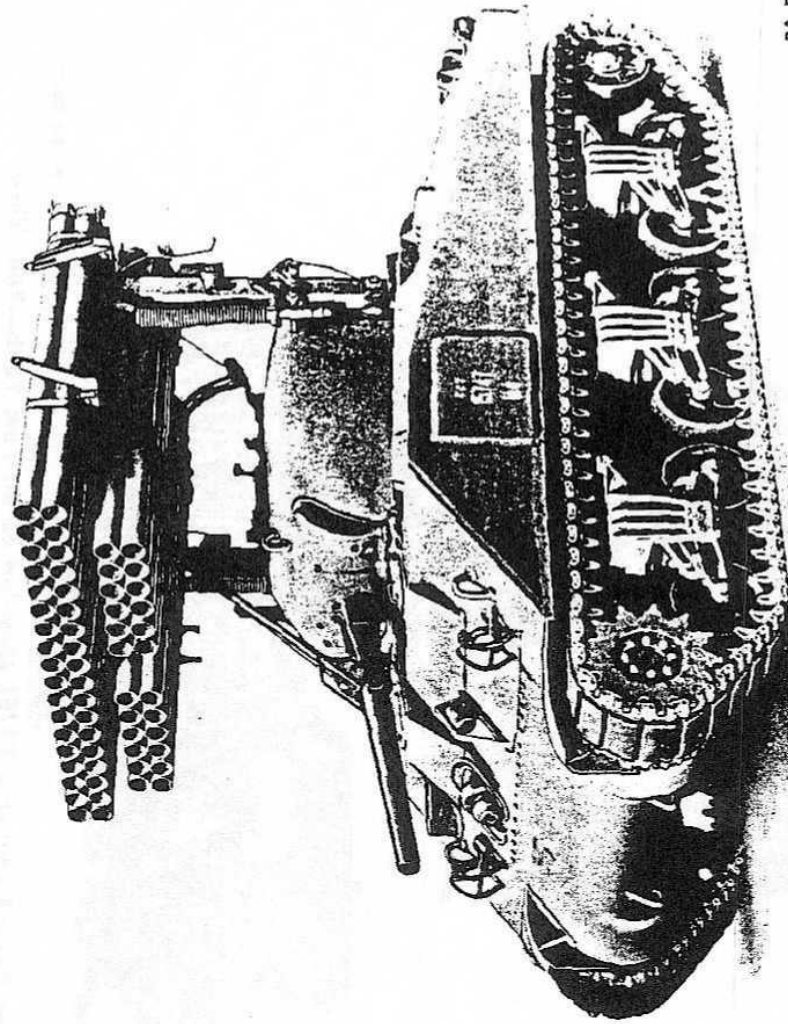

RA PD 90137

Figure 5—4.5-inch Rocket Launcher T34 Mounted on Medium Tank—Front View

TM 9-394

11

4.5-INCH ROCKET MATERIEL FOR GROUND USE

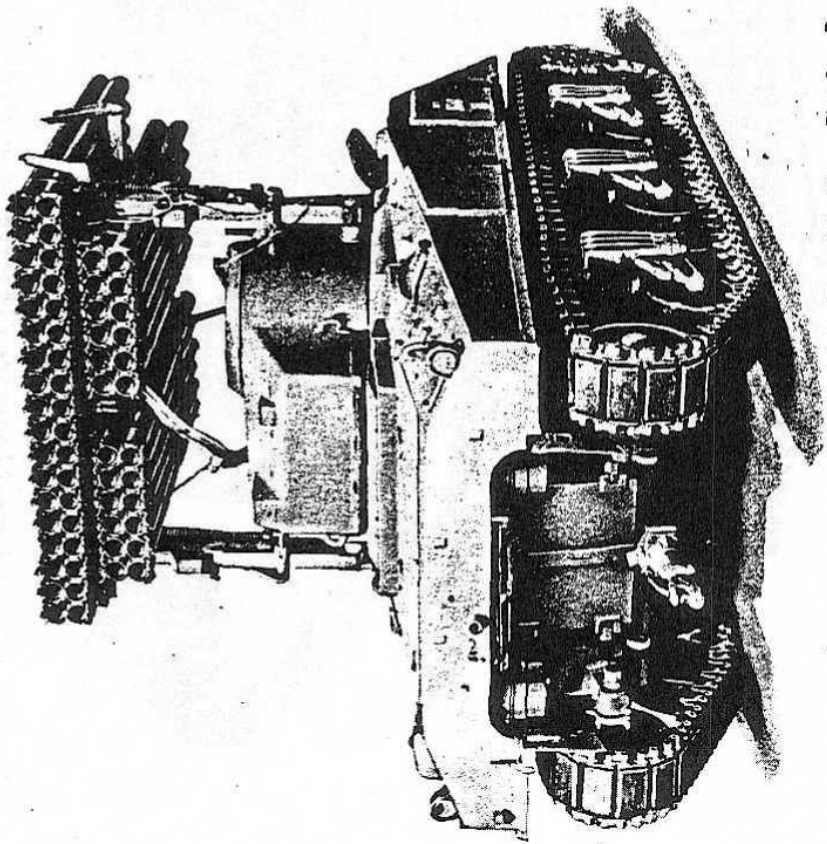

RA PD 90138

Figure 6—4.5-inch Rocket Launcher T34E1 Mounted on Medium Tank—Rear View

DESCRIPTION AND DATA

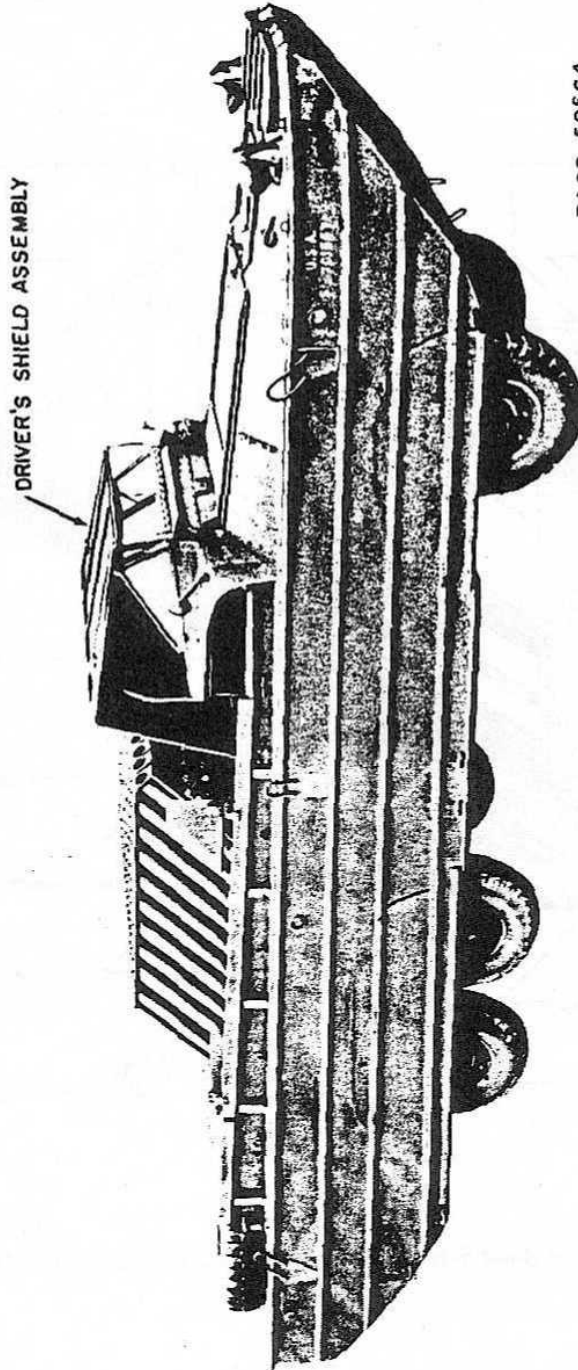
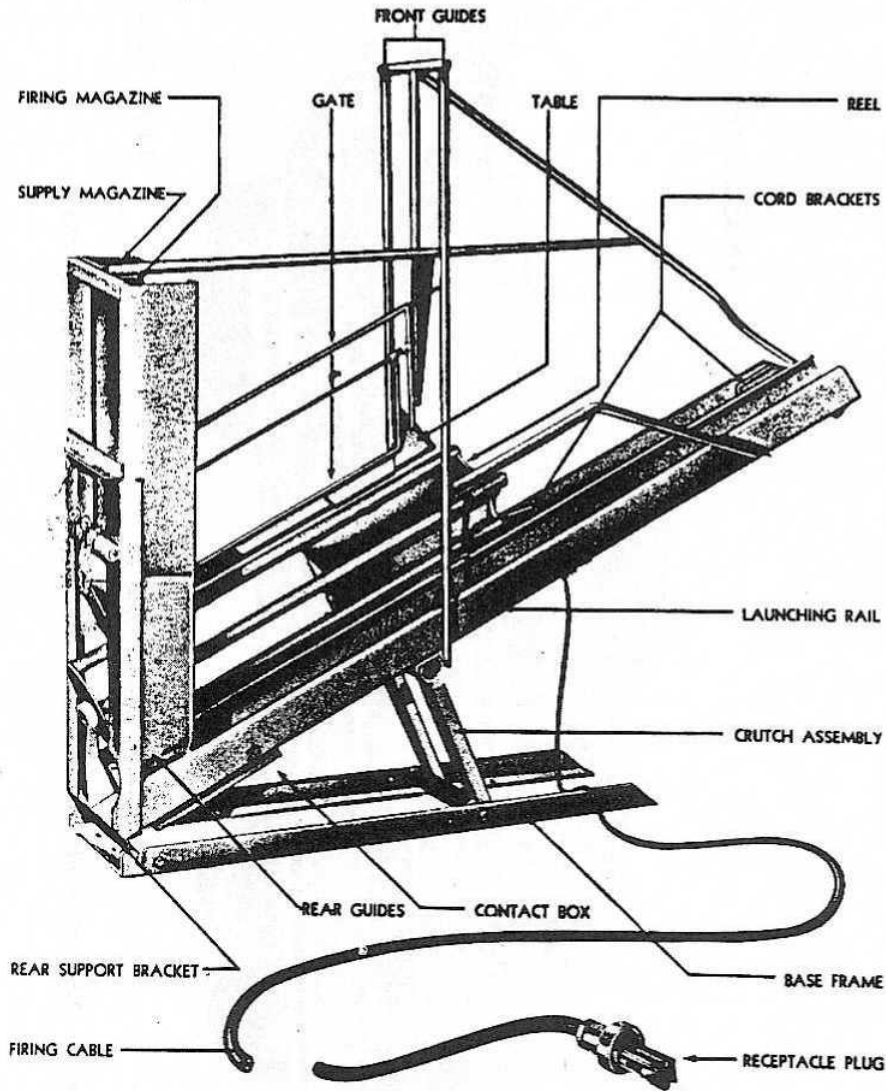

Figure 7—4.5-inch Multiple Rocket Launcher T44 Mounted on DUKW

4.5-INCH ROCKET MATERIEL FOR GROUND USE



RA PD 50583

Figure 8—4.5-inch Automatic Rocket Launcher T45

DESCRIPTION AND DATA

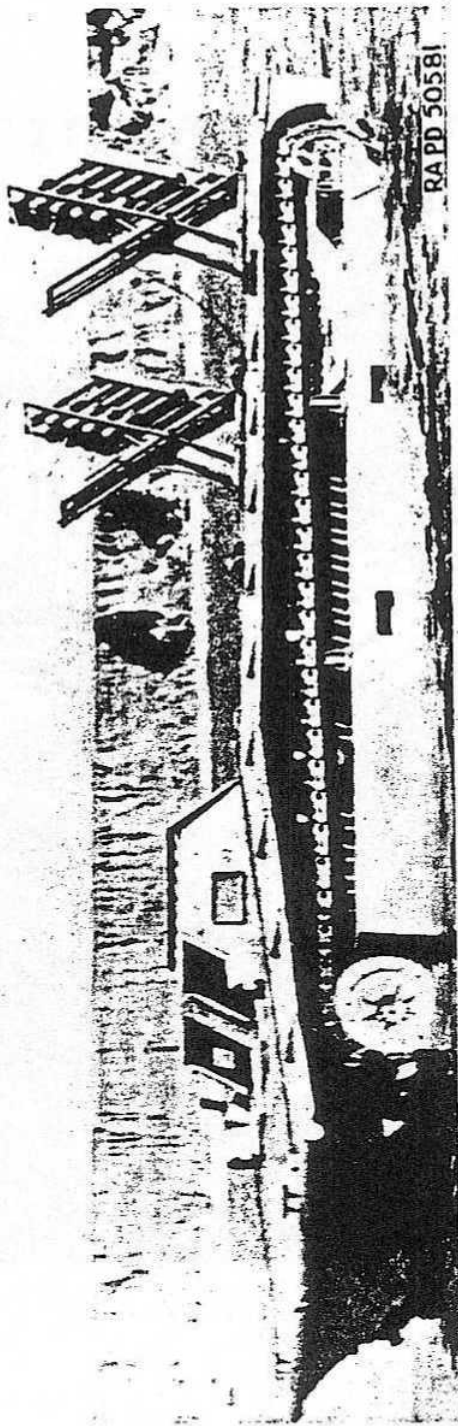

Figure 9—4.5-inch Automatic Rocket Launcher T45 Mounted on LVT

TM 9-394

11

4.5-INCH ROCKET MATERIEL FOR GROUND USE

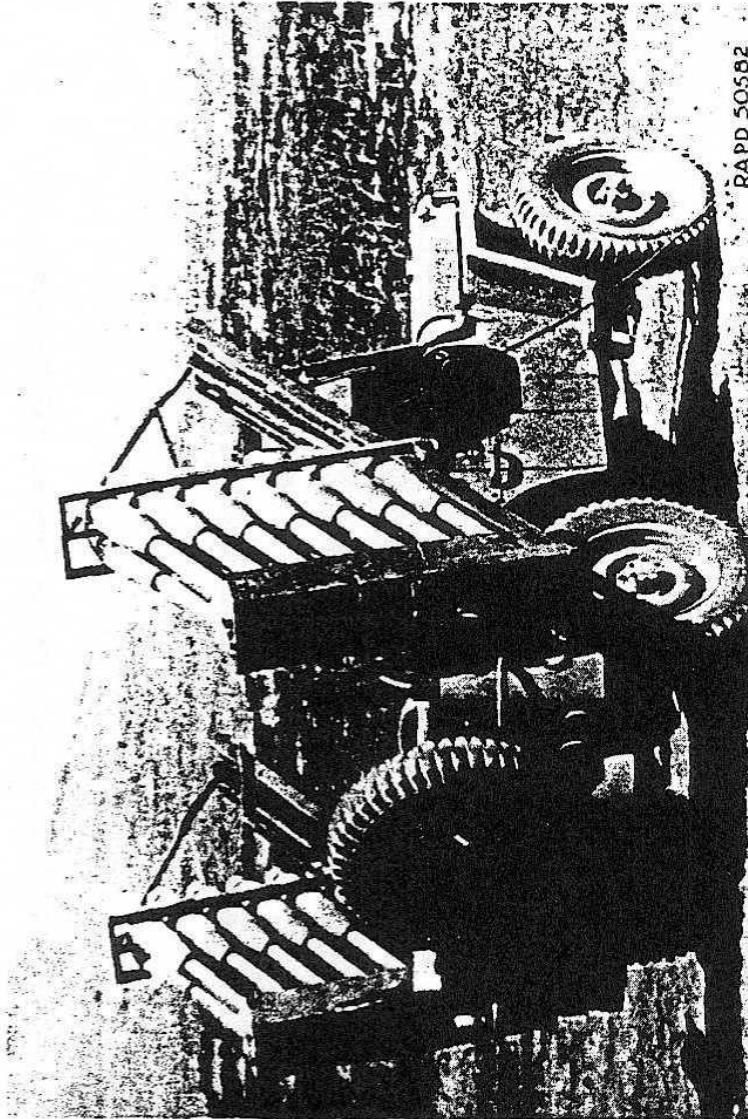

Figure 10—4.5-inch Automatic Rocket Launcher T45 Mounted on 1/4-ton Truck 4 x 4

**DESCRIPTION AND DATA**

**b. 4.5-inch Multiple Rocket Launchers T27 and T27E1.**

Type of mount.....	Ground or truck
Traversing mechanism .....	None
Elevating mechanism .....	Handwheel
Elevating limits.....	-5° to +45°
Sighting mechanism.....	Telescope M6 and Mount T100
Weight of launcher (approx) (lb).....	823
Weight of one tube (approx) (lb).....	54
Weight of mount (approx) (lb).....	391
Over-all length—tubes horizontal and spades extended (approx) (ft) .....	8.5
Over-all width (approx) (ft).....	5
Type of firing mechanism.....	Electric—single or ripple fire
Diameter of tube (in.).....	4.5
Length of tube (ft).....	7.5
Material of tube .....	Steel
Capacity of launcher (rockets).....	8
Rockets authorized .....	Army fin-type

**c. 4.5-inch Rocket Launchers T34 and T34E1.**

Traversing mechanism.....	Controls for tank turret
Elevating mechanism.....	Controls for 75-mm gun
Traversing range .....	360°
Sighting mechanism.....	Tank sights
Weight of launcher (approx) (lb).....	2000
Over-all length (approx) (ft).....	7.5
Over-all width (approx) (ft) .....	7.5
Type of firing mechanism.....	Electric—single or ripple fire
Diameter of tube (in.).....	4.5
Material of tube.....	fiber
Capacity of launcher (rockets).....	60
Rockets authorized.....	Army fin-type

**d. 4.5-inch Multiple Rocket Launcher T44.**

Traversing mechanism .....	None
Elevating mechanism .....	None
Elevating limits.....	45° fixed

**TM 9-394**

11

**4.5-INCH ROCKET MATERIEL FOR GROUND USE**

Sighting mechanism ..... None  
Type of firing mechanism..... Electric—single or ripple fire  
Diameter of tube (in.)..... 4.5  
Length of tube (ft)..... 5  
Material of tubes..... Steel  
Capacity of launcher (rockets)..... 120  
Rockets authorized ..... Navy fin-type

**e. 4.5-inch Automatic Rocket Launcher T45.**

Type of mount..... Ground or vehicle  
Traversing mechanism..... None  
Elevating mechanism..... Crutch assembly  
Elevating limits ..... 0 to +35°  
Sighting mechanism..... None  
Weight of launcher (approx) (lb)..... 157  
Width of launcher (in.)..... 12.12  
Length of launcher (in.)..... 62.6  
Height of launcher (in.)..... 38.8  
Type of firing mechanism..... Electric—single or ripple fire  
Material of launcher..... Steel  
Capacity of launcher (rockets)..... 12  
Rockets authorized..... Navy fin-type



## PART TWO—OPERATING INSTRUCTIONS

### Section III

#### GENERAL

#### 12. SCOPE.

a. Part two contains information for the guidance of the personnel responsible for the operation of this equipment. It contains information on the operation of the equipment with the description and location of the controls.

---

### Section IV

#### SERVICE UPON RECEIPT OF EQUIPMENT

#### 13. GENERAL.

a. Upon receipt of new or used materiel, it is the responsibility of the officer in charge to ascertain whether it is complete and in sound operating condition. A record should be made of any missing parts and of any malfunctions, and any such conditions should be corrected as quickly as possible.

b. Attention should be given to small and minor parts as these are the most likely to become lost and may seriously affect the proper functioning of the materiel.

c. The materiel should be cleaned and prepared for service in accordance with instructions given in this section.

#### 14. LAUNCHER M12.

a. As issued, these launchers are ready for service after emplacement as covered in paragraph 30.

#### 15. LAUNCHERS M12A1 AND M12E2.

a. Since the rocket is shipped in the launcher tube unfuzed, it is necessary to assemble the fuze to the rocket before use. This should be done, if practicable, before going into action because the fuze is boresafe and no additional hazard is involved.

b. Remove waterproof caps from launcher tube. Remove muzzle spacer tube and remove fuze container from spacer. Save tissue paper packing.

c. Push the rear spacer with the rocket ahead of it until the nose of the rocket protrudes from the muzzle of the tube.

d. Assemble fuze to rocket as outlined in paragraph 128.

e. Replace breech cover on tube.

**4.5-INCH ROCKET MATERIEL FOR GROUND USE**

- f. Push rocket back in the tube until rear spacer seats against breech cap.
- g. Replace tissue paper in rear end of front spacer and replace spacer so that it encircles the fuze. Use caution when replacing spacer.
- h. Replace muzzle cap.

**16. LAUNCHERS T27 AND T27E1.**

**a. New Equipment.**

- (1) Test firing control as follows: **CAUTION: Make sure no rockets are in launcher tubes.**
  - (a) Connect generator cable between control box and generator.
  - (b) Insert firing cord plug in its socket.
  - (c) Insert safety plug in its socket.
  - (d) Move "safe" key to fire position.
  - (e) If indicator is not at zero, reset it by cranking generator until dial lamp on control box lights and depress firing button.
  - (f) Move "reset" key to fire position.
  - (g) While cranking generator, depress firing button. Pointer on dial should advance step by step until button is released.
  - (h) Reset indicator to zero.
  - (i) Restore "safe" key to "safe" position.
  - (j) Remove safety plug.
- (2) Remove rust-preventive compound from tubes and from contact fingers and latches by scrubbing with dry-cleaning solvent and then wipe thoroughly dry, using clean, dry burlap, or wiping cloths.
- (3) Apply a light coat of preservative lubricating oil (special) to tubes and all base metal surfaces. Apply a few drops of preservative lubricating oil (special) to release assemblies.

**b. Used Equipment.**

- (1) Test firing control as outlined in a (1) above and remove rust-preventive compound as outlined in a (2) above.
- (2) Inspect contact fingers and latches to be sure that they are not broken and that the springs are operating properly.

**17. LAUNCHERS T34 AND T34E1.**

**a. New Equipment.**

- (1) Inspect the launcher for obstructions inside the tubes.
- (2) Test fire control as follows: **CAUTION: Make sure no rockets are in the launcher tubes.**
  - (a) Insert safety plug in its receptacle in left side of box.

## CONTROLS FOR LAUNCHERS M12, M12A1, AND M12E2

(b) Move "reset" key on top of control box to "fire." Move "safe" key to top of control box to "fire." Red signal lamp on top of box should then light.

(c) Press button in end of firing cord. As long as button is depressed, dial pointer on front of box should move around step by step.

(d) Reset firing control as outlined in paragraph 43 k.

### b. Used Equipment.

(1) The instructions outlined above for new equipment are also applicable for used equipment. In addition the launcher tubes should be inspected for cracks near the muzzle and breech end. Minor flakes or blisters on the inside of the tubes will not affect operation of the launcher.

(2) Inspect the contact fingers and latches to be sure that they are not bent out of shape or broken and that the springs are functioning properly.

## 18. LAUNCHER T44.

### a. New and Used Equipment.

(1) Inspect the launcher for obstructions inside the tubes.

(2) Remove rust-preventive compound from the tube by scrubbing with dry-cleaning solvent and then wipe the tubes thoroughly dry, using clean, dry burlap, or wiping cloths.

(3) Inspect the troughs at the bottom of the 12 tube rack assemblies for obstructions.

(4) Apply a light coat of preservative lubricating oil (special) to tubes and base metal surfaces. Apply a few drops of preservative lubricating oil (special) to release assemblies.

## 19. LAUNCHER T45.

### a. New and Used Equipment.

(1) Remove rust-preventive compound by scrubbing with dry-cleaning solvent and then wiping thoroughly dry, using clean, dry burlap, or wiping cloths.

---

## Section V

## CONTROLS FOR LAUNCHERS M12, M12A1, AND M12E2

### 20. TWO-CELL BATTERY.

a. A two-cell battery (flashlight type) located in the front spacer tube is used to fire a single rocket from the launcher tube.

TM 9-394

21-22

#### 4.5-INCH ROCKET MATERIEL FOR GROUND USE

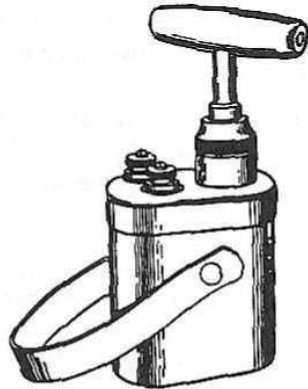

RA PD 83441

Figure 11—Ten-cap Exploder or Blasting Machine

#### 21. TEN-CAP EXPLODER OR BLASTING MACHINE (fig. 11).

a. This machine, a small portable dynamo or magneto weighing about five pounds, is used as a source of electricity for firing a single rocket or a salvo of rockets. It has a removable firing handle which should remain detached until rockets are ready to be fired.

b. Two terminals, located on the upper surface of the body, are used to connect the wires from the rockets.

c. It is operated by turning the handle clockwise.

---

### Section VI

## CONTROLS AND INSTRUMENTS FOR LAUNCHERS T27 AND T27E1

#### 22. CONTROLS.

a. **Safety Plug** (fig. 12). A safety plug, located in a socket on the upper left side of the firing control box panel, provides a means of breaking the circuit and keeping it open while the launcher is being loaded with ammunition, or at any other time that it may not be safe to fire.

b. **Firing Button** (fig. 12).

(1) A firing button located on the end of the firing cord attached to the upper right side of the control box panel provides a means of

CONTROLS AND INSTRUMENTS FOR LAUNCHERS  
T27 AND T27E1

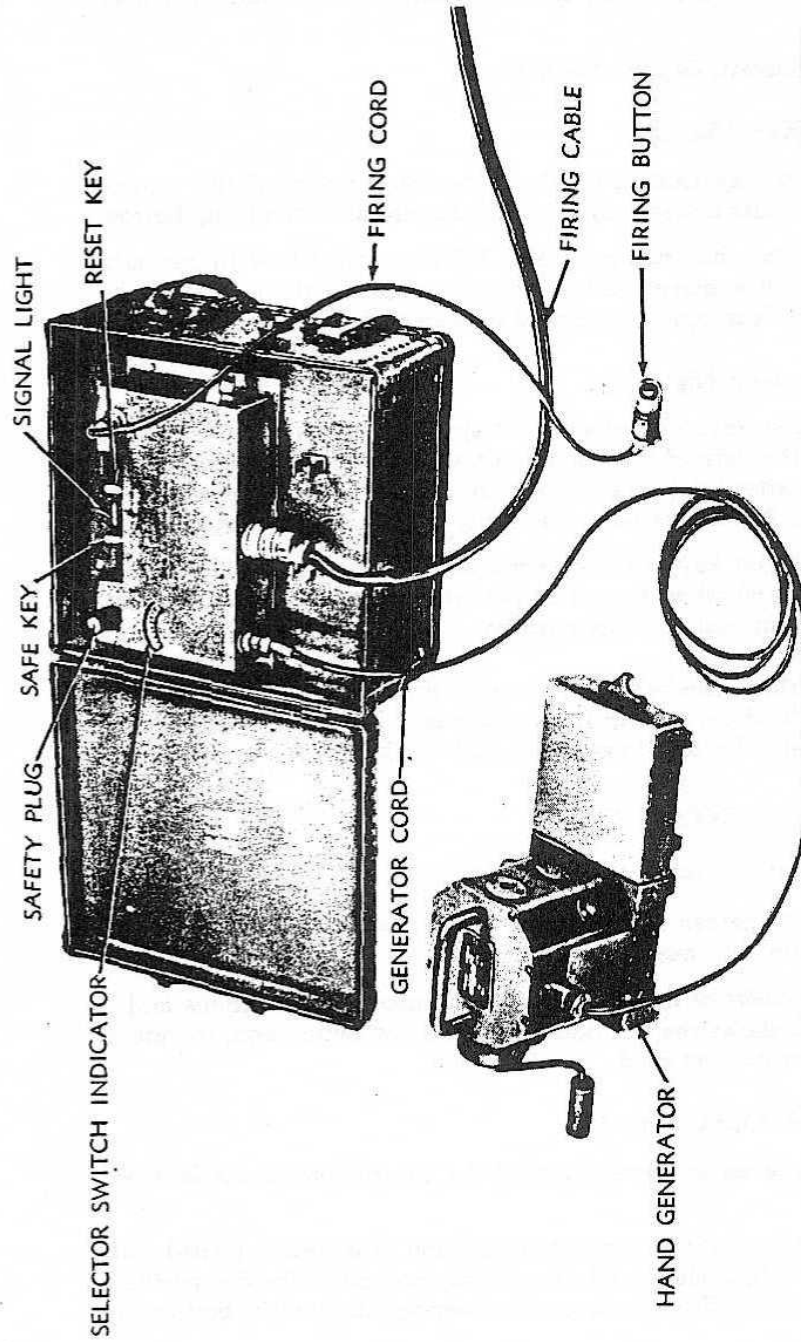

RA PD 90145

Figure 12—Firing Control Box and Generator for Multiple Rocket Launchers T27 and T27E1

**4.5-INCH ROCKET MATERIEL FOR GROUND USE**

completing the electric circuit to the rockets in order that they may be fired.

(2) To operate, depress the button.

**c. Safe Key (fig. 12).**

(1) A safe key located on the upper center part of the control box panel provides a means of breaking the circuit to the firing button.

(2) This key has two positions. When vertical it is in the safe position and when moved to the right it completes the circuit to the firing button. It is manually moved to either position.

**d. Reset Key (fig. 12).**

(1) A reset key, located on the upper center part of the control box panel to the right of the safe key provides a means of resetting the firing control after firing has stopped, in order that the firing sequence will start with No. 1 tube when the firing button is again depressed.

(2) The reset key has two positions. When vertical it is in the reset position and when moved to the left it is in the firing position. It is manually moved to either position.

**e. Elevating Handwheel.** An elevating handwheel is attached to the left side of the mount. This handwheel is turned counterclockwise to elevate the launcher tubes, and clockwise to depress them.

**23. INSTRUMENTS.**

**a. Selector Switch Indicator (fig. 12).**

(1) In the center of the firing control box panel is a selector switch indicator enclosed by a window.

(2) It consists of a dial with eight numbered graduations and a pointer which shows the position of the selector switch and, therefore, the number of rockets fired.

**b. Signal Light (fig. 12).**

(1) On the upper center part of the control box panel is a red signal light.

(2) This light illuminates when the hand generator is turned with the safety plug in position and the safe key moved to the fire position. It indicates that sufficient current is entering the control box to fire the rockets.

## Section VII

**CONTROLS AND INSTRUMENTS FOR LAUNCHERS  
T34 AND T34E1****24. CONTROLS.****a. Safety Plug (fig. 13).**

(1) A safety plug is located in a socket on the left side of the firing control box. When this plug is removed from its socket, it breaks the circuit to the firing button and keeps it open while the launcher is being loaded with ammunition, or at any other time that it may not be safe to fire.

(2) To remove the safety plug withdraw it from its socket.

**b. Firing Button (fig. 13).**

(1) A firing button, located in the end of the firing cord attached to the left side of the control box, provides a means of completing the electric circuit to the rockets, in order that they may be fired.

(2) To operate, depress the button.

**c. Safe Key (fig. 13).**

(1) A safe key, located on the top of the control box, provides a means of completing the circuit to the firing button.

(2) This key has two positions. When vertical, it is in the "safe" position and, when moved to the right, it is in the "fire" position. It is moved manually to either position.

**d. Reset Key (fig. 13).**

(1) A reset key, located on top of the control box to the right of the safe key, provides a means of resetting the firing control box after firing has stopped, in order that the firing sequence will start with No. 1 tube, when firing button is again depressed.

(2) The reset key has two positions. When vertical it is in the reset position and, when moved to the left, it is in the fire position. It is moved manually to either position.

**e. Exactor Transmitters (fig. 14).**

(1) The exactor transmitters are manually operated controls located inside the turret and are for the purpose of jettisoning the launcher.

(2) Three transmitters are fastened side by side and their levers are strapped together so that they must be operated simultaneously.



4.5-INCH ROCKET MATERIEL FOR GROUND USE

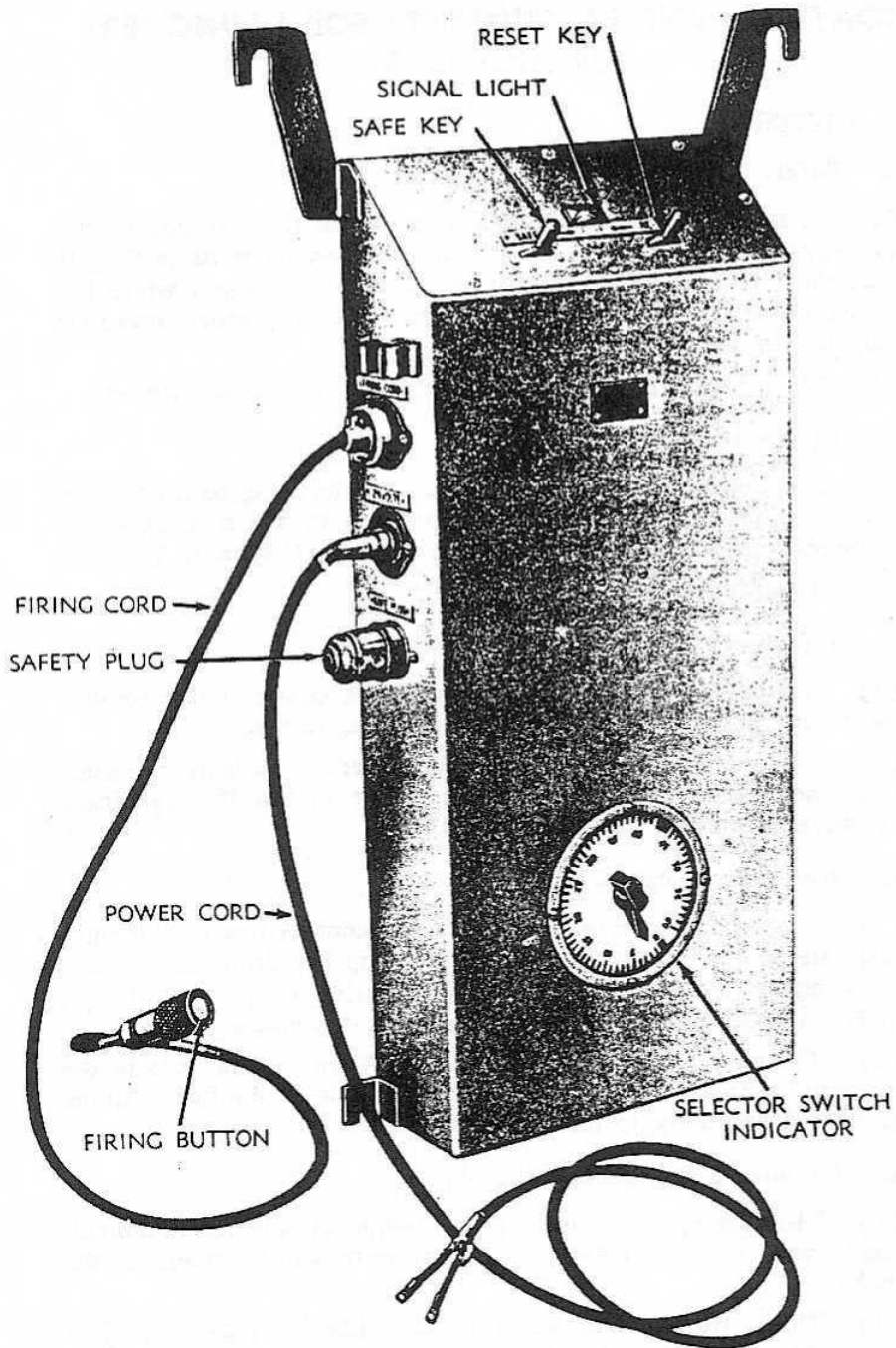

RA PD 90152

Figure 13—Firing Control Box for Rocket Launchers T34 and T34E1



**CONTROLS AND INSTRUMENTS FOR LAUNCHERS  
T34 AND T34E1**

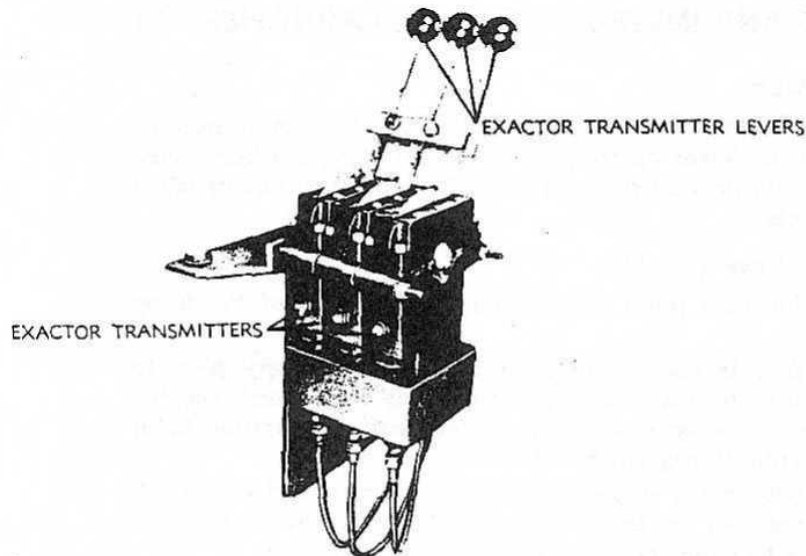

RA PD 90150

**Figure 14—Exactor Transmitters**

(3) On exactor transmitters of present manufacture the center lever is provided with a latch to prevent accidental operation.

(4) To operate, lift the latch on the center lever if one is provided, pull the three levers together in one stroke from front to rear.

**25. INSTRUMENTS.**

**a. Signal Light (fig. 13).**

(1) On the top of the control box is located a red signal light.

(2) This lamp lights when the safety plug is in position in its socket and the safe key is moved to the fire position. It indicates that current is flowing into the box and the circuit is energized and ready for firing.

**b. Selector Switch Indicator (fig. 13).**

(1) In the center of the firing control box is a selector switch indicator enclosed by a circular window.

(2) It consists of a dial with 60 numbered graduations and a pointer which shows the position of the selector switch and, therefore, the number of rockets fired.

4.5-INCH ROCKET MATERIEL FOR GROUND USE

Section VIII

CONTROLS AND INSTRUMENTS FOR LAUNCHER T44

26. CONTROLS.

a. **Firing Buttons** (fig. 15). "Hold" and "fire" push buttons are located on the lower center part of the firing control box panel. These buttons are depressed to complete the electrical circuit when firing the rockets.

b. **Safety Plugs** (fig. 15).

(1) Two identical plugs are located on the panel of the firing control box.

(2) The plug in the lower center is used as a safety plug, to provide a positive means of breaking the firing circuit and keeping it open, while the launcher is being loaded with ammunition or at any other time that it may not be safe to fire.

(3) The plug in the upper right-hand corner is used as a knob for manual operation of the selector switch, in the event that the motor connected to the selector switch fails to operate.

(4) Two receptacles for storing these plugs, when not in use, are located at the top of the panel. During periods of inactivity, the plugs should be left in these receptacles.

(5) In order to complete the firing circuit, the safety plug is lifted from its receptacle and inserted in its socket.

(6) In order to manually operate the selector switch, the cap screwed over the pedestal is removed, and the plug, used as a knob, is removed from its receptacle and inserted in the pedestal and turned, while pressing down.

c. **Master Power Switch** (fig. 15).

(1) A toggle switch located on the lower portion of the panel to the left of the "hold" and "fire" buttons provides a means of breaking the firing circuit and keeping it open after the safety plug has been inserted in its socket.

(2) When turned on, the switch lights a green indicating lamp, located in the center of the panel on the extreme left side, thereby showing that the control box is set to fire.

27. INSTRUMENTS.

a. **Selector Switch Indicator** (fig. 15).

(1) In the center of the firing control box panel, is a selector switch indicator. This indicator is enclosed by two windows, one is circular and the other rectangular.

## CONTROLS AND INSTRUMENTS FOR LAUNCHER T45

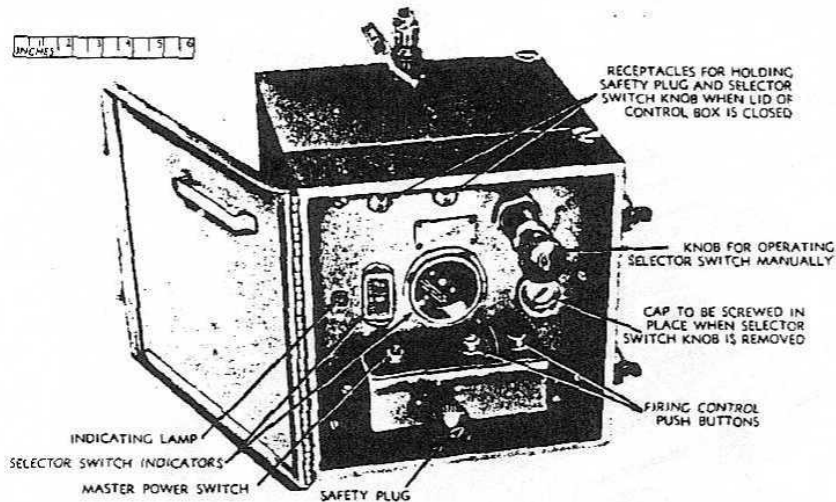

RA PD 90716

Figure 15—Firing Control Box—Launcher T44

(2) The circular window houses two white arrows, each on its own disk. During normal operation, these arrows rotate together so as to point to each other. If they are not in line, indication is given that the selector switch has been operated manually or otherwise disturbed, since firing stopped.

(3) The rectangular window shows the position of the selector switch and therefore the number of rockets fired.

### Section IX

## CONTROLS AND INSTRUMENTS FOR LAUNCHER T45

### 28. CONTROLS.

#### a. Safety Plug (fig. 16).

(1) A safety plug, located in a socket in the upper right-hand corner of the firing control box panel, provides a positive means of breaking the circuit and keeping it open while the launcher is being loaded with ammunition, or at any other time that it may not be safe to fire.

(2) The safety plug is kept in its receptacle, on the right side of the control box, except when the launcher is to be fired, at which time it is removed by unscrewing the receptacle cap and withdrawing it from the receptacle. It is then inserted in its socket.

4.5-INCH ROCKET MATERIEL FOR GROUND USE

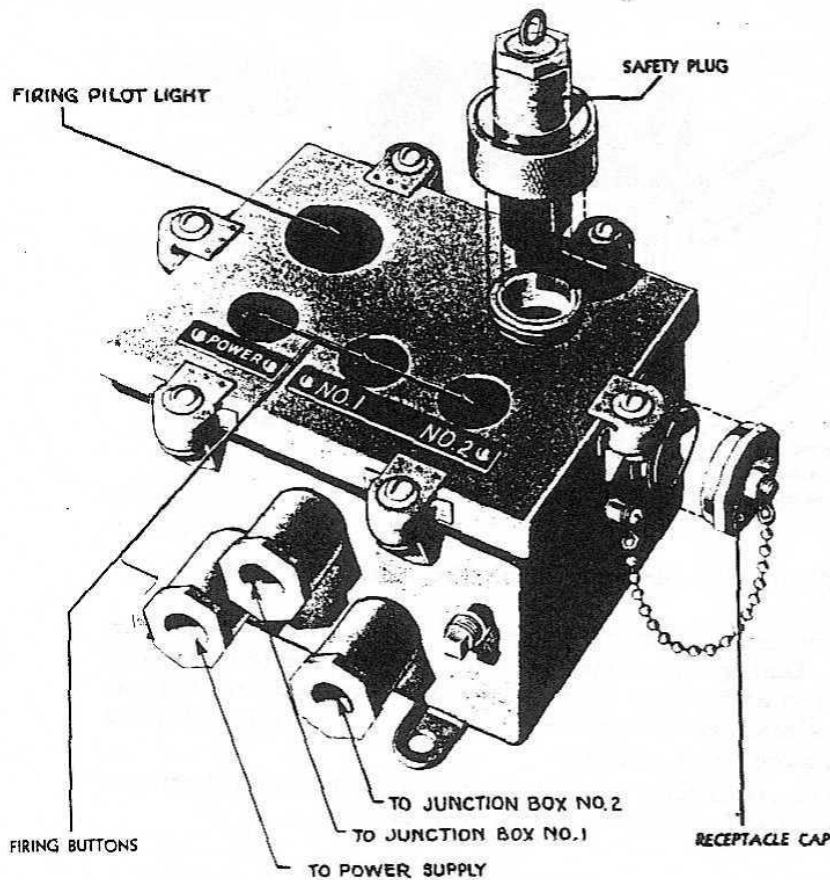

RA PD 50588

Figure 16—Firing Control Box—Launcher T45

b. Power Button (fig. 16).

(1) A power button, located on the lower left-hand corner of the panel, provides a means of breaking or completing the electric firing circuits after the safety plug has been inserted in its socket.

(2) The button is depressed to operate.

c. Firing Buttons (fig. 16).

(1) Two firing buttons, located on the panel to the right of the power button, provide a means of completing the electric circuit to the rockets, in order that they may be fired. Each button controls a separate launcher.

(2) To operate, these buttons are depressed.

**OPERATION OF LAUNCHERS M12, M12A1, AND M12E2 UNDER USUAL CONDITIONS****29. INSTRUMENTS.**

a. **Firing Pilot Light** (fig. 16). A firing pilot light, located in the upper left-hand corner of the control box, lights when the power button is depressed, thereby showing that current is available and the control box set to fire the rockets.

---

**Section X****OPERATION OF LAUNCHERS M12, M12A1, AND M12E2 UNDER USUAL CONDITIONS****30. EMPLACEMENT** (fig. 17)**a. Precautions.**

(1) The muzzle of the launcher tube, when in firing position, must be at least 12 inches away from all obstructions, such as the ground, rocks, grass, branches, and so forth. When the Rocket M8 leaves the launcher, the fins open to a diameter of 12 inches and therefore a minimum clearance of at least 12 inches in diameter must be provided for the passage of the rocket to the target. If the fins should strike ground, leaves, branches and so forth, the rocket will be deflected from its course.

(2) If it is necessary to move the launcher when the front or rear end of the tube is open, be careful to maintain the launcher in an approximately horizontal position, in order to prevent the rocket from sliding out and breaking the igniter wires or causing a premature explosion.

(3) Make certain the rocket propelling charge is correct for the atmospheric temperature. These adjustments must be made by ordnance personnel as outlined in paragraph 122.

b. Place launcher, as issued, on ground with tripod facing upward.

c. Remove the two packing straps, taking care not to lose mounting cams.

d. Set up tripod by spreading all three legs to a full position. If the ground requires use of spades on the legs, remove the three spades from the spacer inside the front of the launcher tube, and slip one spade over the end of each leg.

e. Hang the packing straps, together with the mounting cams, over top of the tripod and position the tripod so that the two mounting legs are to the right of the firing position.

4.5-INCH ROCKET MATERIEL FOR GROUND USE

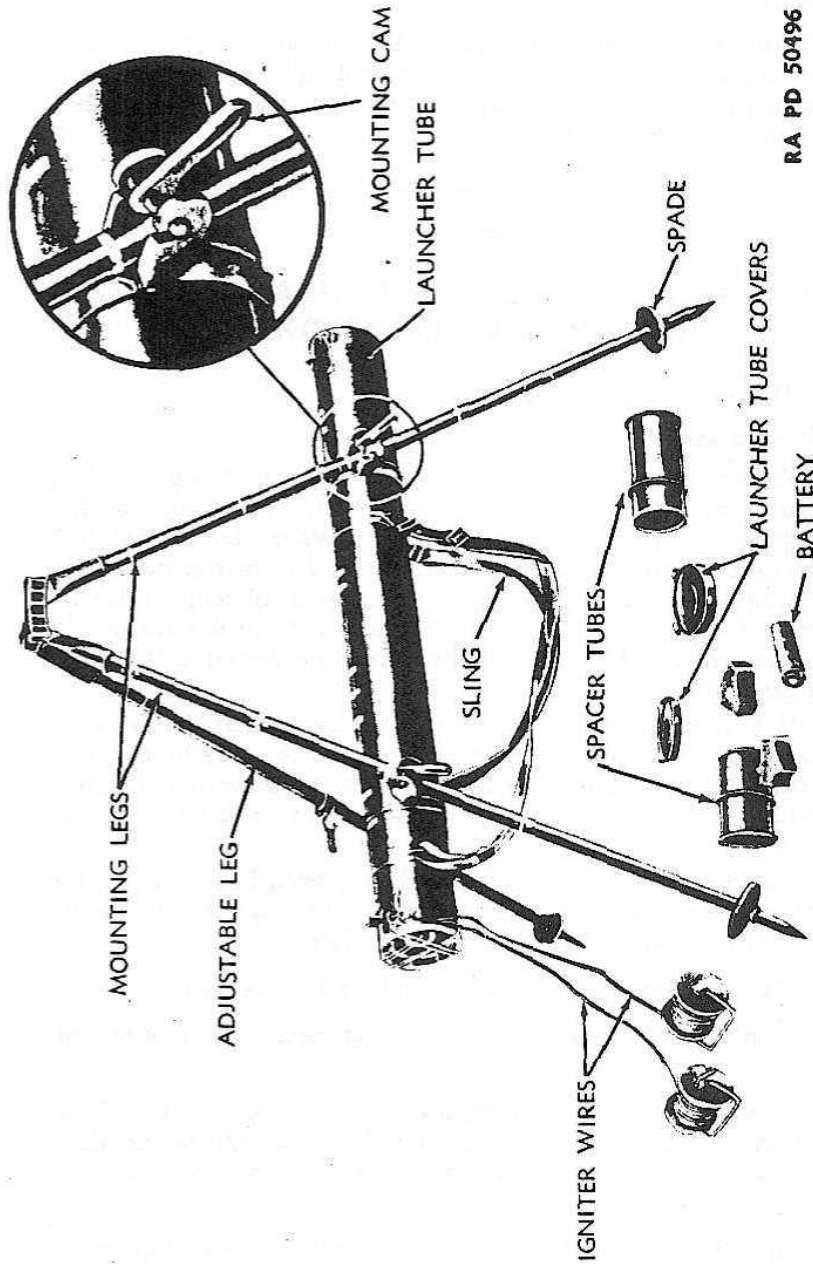

RA PD 50496

Figure 17—Rocket Launcher M12—Assembled

**OPERATION OF LAUNCHERS M12, M12A1, AND M12E2 UNDER USUAL CONDITIONS**

f. Estimate approximately the height above the ground at which the launcher will be emplaced. The maximum position is approximately 30 inches above the ground. A minimum clearance of at least 12 inches in diameter must be provided for the passage of the rocket to the target.

g. Release latch of front mounting support and slide the support along the tube so that the support lines up between the pair of stripes which correspond with the desired elevation. If the desired elevation is less than 18 inches, the front support must be removed from the tube and placed on the other side of the sling strap.

h. Line up white stripe on top of mounting support strap with white line on top of launcher, and fasten mounting support latch.

i. Make sure that rear mounting support is positioned between the last two stripes on the launcher tube in the same manner as the front mounting support, and make sure that the latch is fastened.

j. Place launcher tube underneath tripod, holding it horizontal and parallel to the mounting legs.

k. Grasp launcher tube at each end and raise it to the approximate elevation. Position the U-shaped pieces on mounting supports around the mounting legs of the tripod and, while holding the launcher tube in the center, take mounting cam from strap on top of tripod, and insert each locking cam in support with the cam handle upward and cam projection outward. Tighten the launcher tube in place by rotating the cam downward.

l. Release cover latches and remove front and rear launcher tube covers.

m. Remove front spacer from the launcher tube and withdraw the battery from inside the spacer. Remove the three spades if not previously removed.

n. Remove rear spacer carefully; withdraw the two spools of wire from inside of spacer and place the spools of wire on the ground. Be careful not to break the wire leading to the rocket. *Make sure launcher tube is clear except for rocket.*

**NOTE:** *On rocket launchers of present manufacture the wire is wound around the outside of the rear spacer, which eliminates the two spools.*

o. Reach inside the rear of the launcher tube and push the rocket forward until the fuze is exposed at the front end of the tube.

**NOTE:** *If the rocket in the Launcher M12 has not been fuzed, assemble fuze as outlined in paragraph 124. For fuzing of rocket in Launcher M12A1 or M12E2 see paragraph 15.*



TM 9-394

30

4.5-INCH ROCKET MATERIEL FOR GROUND USE

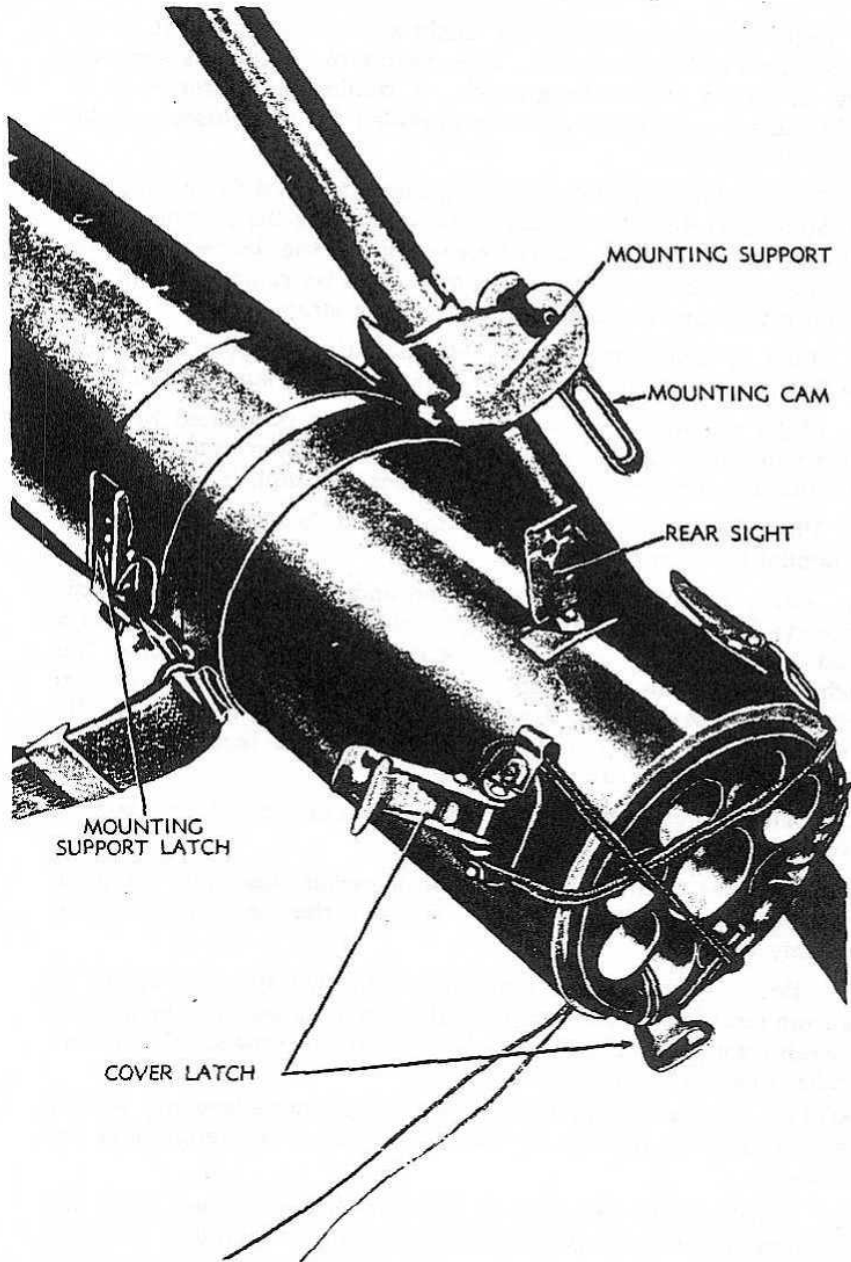

RA PD 65208

Figure 18—Rocket Igniter Wires Fastened to Clips on Breech End of Launcher Tube



**OPERATION OF LAUNCHERS M12, M12A1, AND M12E2 UNDER USUAL CONDITIONS**

p. Set the fuze for the action required (delay or superquick), paragraph 123 b or 127 a. Remove the safety pin from the fuze (Launcher M12 only) and push the rocket back into the tube until the rear end of the rocket is flush with the rear end of the tube. *NOTE: When pushing the rocket back into tube, do not push directly on point of fuze.*

q. Grasp the two rocket igniter wires (fig. 18) and hook them under one of the clips attached to the rear cover latches; then draw the two wires across the back open end of the launcher tube to the next latch and hook in the clip; then bring the wires across to the third latch; then back to the original clip. This will prevent the projectile from sliding out of the launcher tube before being fired.

r. Aim the launcher by sighting along the open sights or along the white line painted on top of the tube. Turn the tripod to obtain the proper direction. When using the rear peep sight, bend it perpendicular to the tube as shown in figure 40. Aim by centering the front sight in the rear peep sight and at the same time alining the front sight on the target.

s. Push the legs into the ground and set the adjustable leg so as to obtain desired elevation of the launcher. *NOTE: The position of the launcher tube on the mounting legs, and the position of the adjustable leg provide variation in heights above the ground of both tripod and tube.*

t. Pick up the spools and reel out the wire while proceeding to the firing position. Be sure to allow slack in order to prevent the tripod from being tipped over.

**31. EMPLACEMENT FOR FIRING SALVOS.**

a. Up to three rockets may be fired in one salvo.

b. Embrace each launcher as described in the preceding paragraph.

c. When setting up for salvo firing, do not place launchers closer than fifteen feet. This is to prevent the blast of one rocket deflecting neighboring rockets.

d. All rockets must be wired in parallel with the exploder terminals, in order to fire a salvo. The wiring is done as follows:

(1) Draw the igniter wires from launcher which is furthest from the exploder position, to the exploder position. If necessary, splice additional wire to these lines.

(2) Strip insulation and splice one igniter wire from each of the

4.5-INCH ROCKET MATERIEL FOR GROUND USE

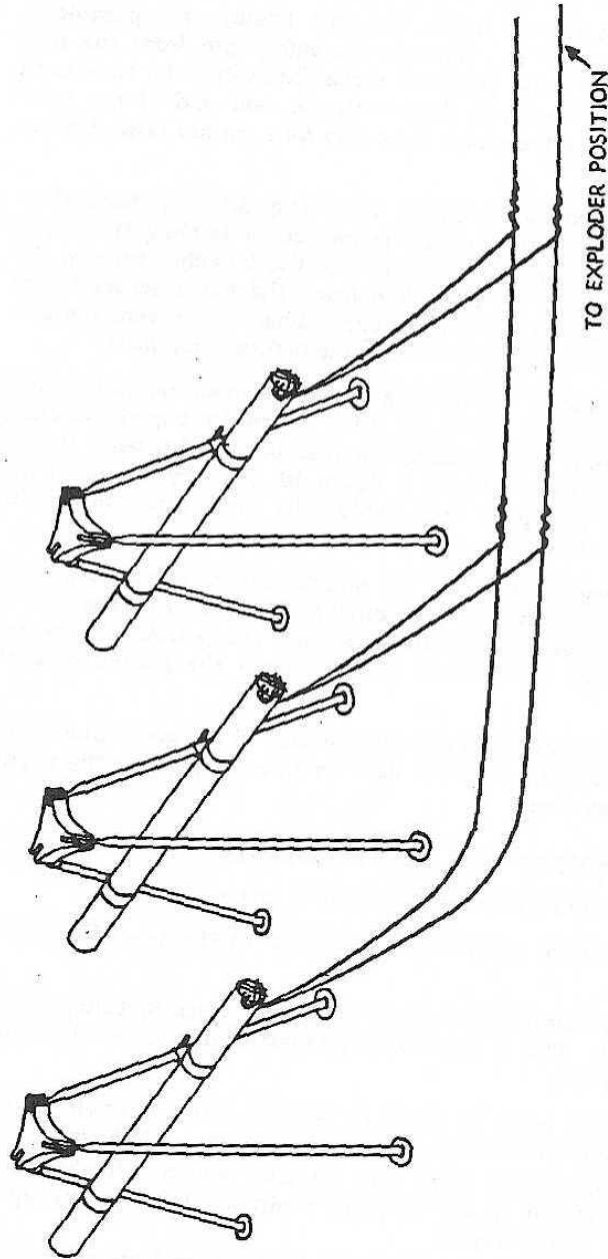

BA PD 91992

Figure 19—Method of Wiring for Salvo Firing

## OPERATION OF LAUNCHERS M12, M12A1, AND M12E2 UNDER USUAL CONDITIONS

other launchers in the salvo to one of the lines leading to the exploder position.

(3) Splice the other igniter wire from each of the other launchers to the second line leading to the exploder position. Figure 19 shows the proper wiring for three launchers in a salvo.

(4) An alternate method of preparing this wiring is to connect one wire from each of the launchers to one terminal of the exploder, and to connect the other wire from each of the launchers to the other terminal of the exploder. This can only be done when it is possible to bring wires from all the launchers to the exploder position.

### 32. ELECTRICAL CONNECTIONS.

a. **Important.** Wires must be carefully and correctly spliced (uninsulated portion of two or more connected wires) to insure the passage of electricity from one wire to the others. Electricity may not pass across a spliced connection if insulation, grease, or dirt is present.

#### b. To Splice Wires.

(1) Remove the insulation from 3 to 4 inches of the ends of the wires to be spliced. Be careful not to damage the wire when removing the insulation. Scrape the bare ends lightly with a knife blade, being careful not to damage the wire, to insure that all insulating material is removed.

(2) Hold the bare sections of wire together and form a hairpin bend in the center of the bare section, using a small rod or similar tool. (A pencil, the neck of a cal. .30 cartridge, or the handle of a pair of pliers will be satisfactory.) (fig. 20A).

(3) Hold the wires firmly and twist into a loop with four or five turns. Be sure the wires are tightly twisted (fig. 20B).

(4) Remove the twisting tool. Bend the insulated parts of the wires into four legs so as to hold the splice off the ground. If a wire has a free end at the splice, bend the end up (fig. 20C).

#### c. Handling Wire.

(1) Be careful not to kink or break wires.

(2) Be careful not to upset emplaced launchers while drawing wires to the next launchers or to the exploder.

(3) Uninsulated wires must not come in contact with the ground. Spliced joints may be held up by supporting them on dry stones or dry sticks.

(4) If raining, insulate the splices with tape.

(5) Do not allow a bare wire to touch the launcher legs.

4.5-INCH ROCKET MATERIEL FOR GROUND USE

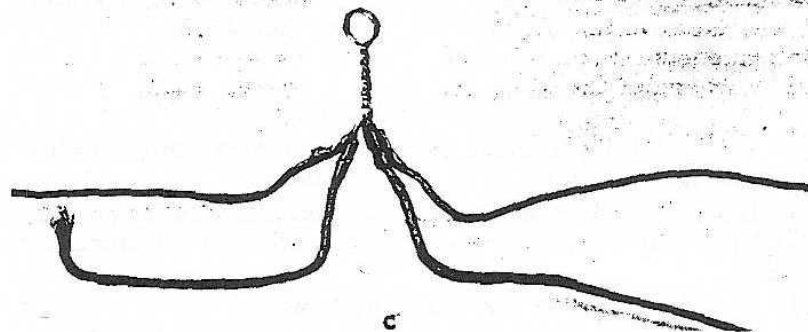
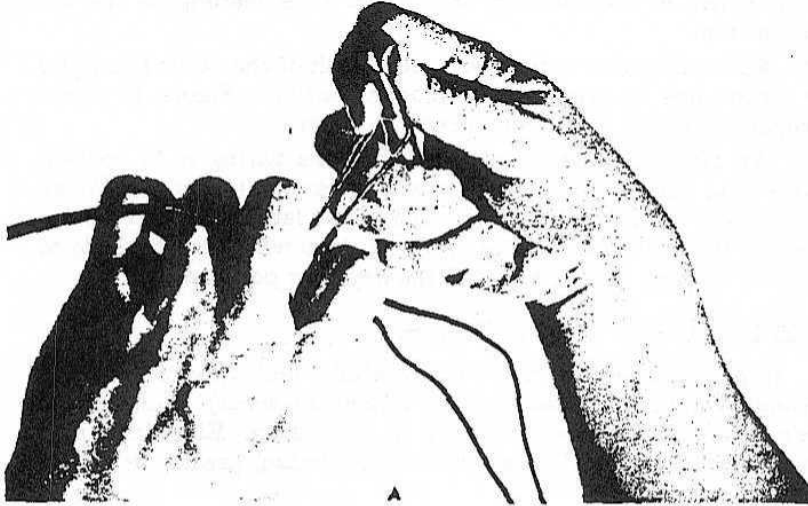

RA PD 65205

Figure 20—Splicing Wires

**OPERATION OF LAUNCHERS M12, M12A1, AND M12E2 UNDER USUAL CONDITIONS****33. FIRING.****a. To Fire a Single Rocket With a Battery.**

**CAUTION:** *Make sure that all personnel are clear of the launchers and at least 75 feet behind them. The position of the operator should be to the side of the launcher and at least 50 feet away.*

(1) Hold the bare end of one of the wires against the bottom of the battery.

(2) To fire, touch the bare end of the other wire to the center contact at the top of the battery.

**b. To Fire a Single Rocket With an Exploder.**

(1) Remove the firing handle if it has not been previously removed.

(2) Make sure that terminals on exploder are clean and dry.

(3) Make sure that the lead wires to be connected to the exploder terminals have the insulation removed from their ends, and are clean and dry.

(4) Connect the uninsulated end of one lead wire to one terminal on the exploder, and the other wire to the other terminal. To do this, loosen the nut on the terminal, hook or wind the clean and uninsulated end of the lead wire around the binding post, and tighten the nut down on the wire. Repeat with the other wire and other terminal.

(5) To fire, operate the exploder as follows:

(a) Hold the machine in the left hand, strap across the back of hand.

(b) Insert the firing handle.

(c) Grasp the firing handle with the right hand, knuckles towards terminals of machine, and twist the handle clockwise as rapidly as possible while twisting the machine counterclockwise. Remove the firing handle after firing the rocket.

**c. To Fire a Salvo.**

(1) Batteries which are issued with the launcher cannot be used to fire a salvo.

(2) Check to be sure that all rockets to be fired in the salvo are properly wired as described in paragraph 31.

(3) Connect to one exploder terminal the end of one of the lines which carries half of the rocket igniter wires. Connection is to be made as described in b (4) above.

(4) Connect to the other exploder terminal the end of the other line which carries the other half of the rocket igniter wires.

(5) To fire, operate the exploder as outlined in b (5) above.

**4.5-INCH ROCKET MATERIEL FOR GROUND USE**

**34. MISFIRES—LAUNCHER M12.**

a. In the event that the rocket igniter explodes but the rocket is not fired out of the launcher tube, disconnect the exploder or battery and wait 10 minutes before approaching the launcher. Then remove the rocket from the tube, insert the safety pin in the fuze, and return the rocket and launcher to ordnance personnel for disposition.

**35. MISFIRES—LAUNCHERS M12A1 AND M12E2.**

a. Proceed as in paragraph 34 above and in addition, after removing the rocket from the tube, remove the fuze and return the fuze, rocket, and launcher to ordnance personnel for disposition. The fuze will be repacked and resealed in the fuze container, but the fuze container will be kept separate and not replaced in the launcher.

---

**Section XI**

**OPERATION OF LAUNCHERS T27 AND T27E1 UNDER USUAL CONDITIONS**

**36. EMPLACEMENT OF LAUNCHER T27 (figs. 21 and 22).**

a. Assemble the cradle assembly to the top rear of the mount by inserting the trunnions in the brackets. Make sure the elevating screw assembly is facing the front foot. Insert bolts through bracket and trunnion, assemble and tighten nuts, and install cotter pins.

b. Position the end of the elevating screw assembly in its bracket on the front foot, insert bolt through bracket and elevating screw, assemble and tighten nut, and install cotter pin.

c. Place the eight launcher tube assemblies in position on the cradle and tighten the launcher tube securing bolts.

d. Place the tube spacer assembly in position on top of the tubes approximately 18 inches from the front end so that the four bolts protrude between the tubes.

e. Place tube spacer bar over the four bolts and assemble and tighten thumb nuts.

f. Loosen the four nuts on each strut clamp attached to the two corner posts at the rear of the mount. Lift the struts up, swing them around to the rear and position them in the U-brackets welded to the rear corner posts. Tighten the four bolts on each clamp.

**OPERATION OF LAUNCHERS T27 AND T27E1 UNDER  
USUAL CONDITIONS**

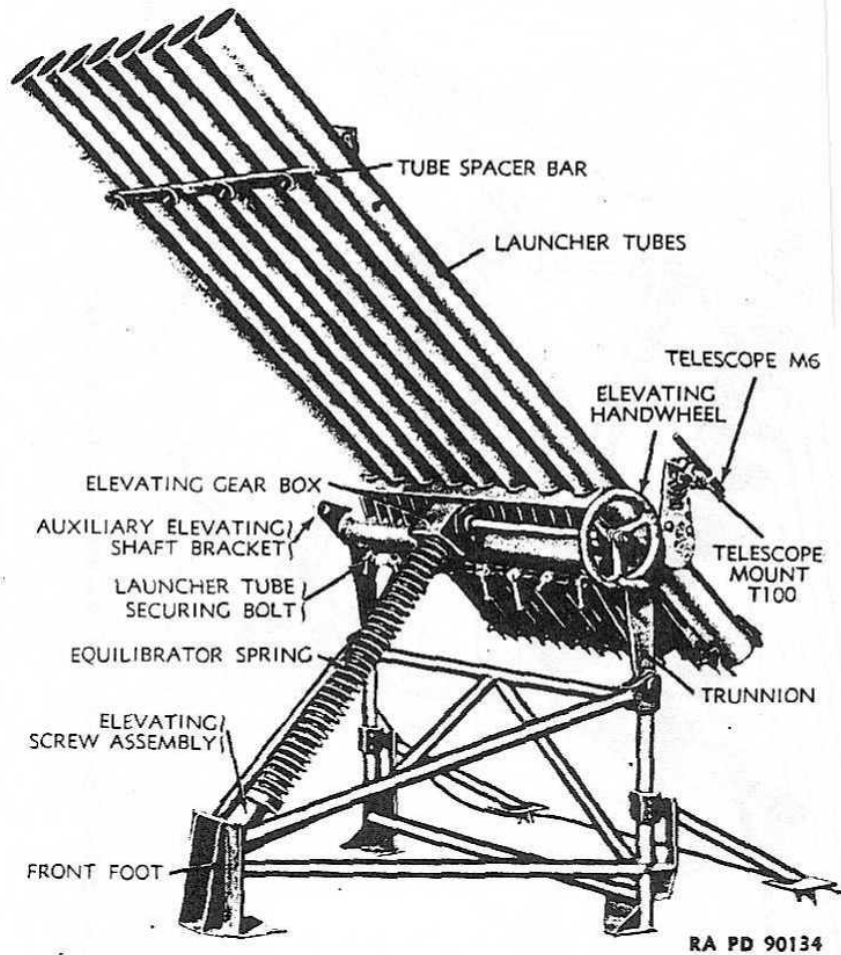

**Figure 21—Rocket Launcher T27 Assembled—Tubes Vertical**

g. Open rear cover of firing control box and remove 50-foot firing cable and gunner's quadrant (fig. 44).

h. Open front cover of firing control box and remove generator cord, firing cord, and telescope (fig. 43).

i. Insert firing cable plug in connector on right side of cradle, and assemble coupling nut to connector. Insert plug on other end of firing cable in socket on firing control box panel, and assemble coupling nut to socket.



4.5-INCH ROCKET MATERIEL FOR GROUND USE

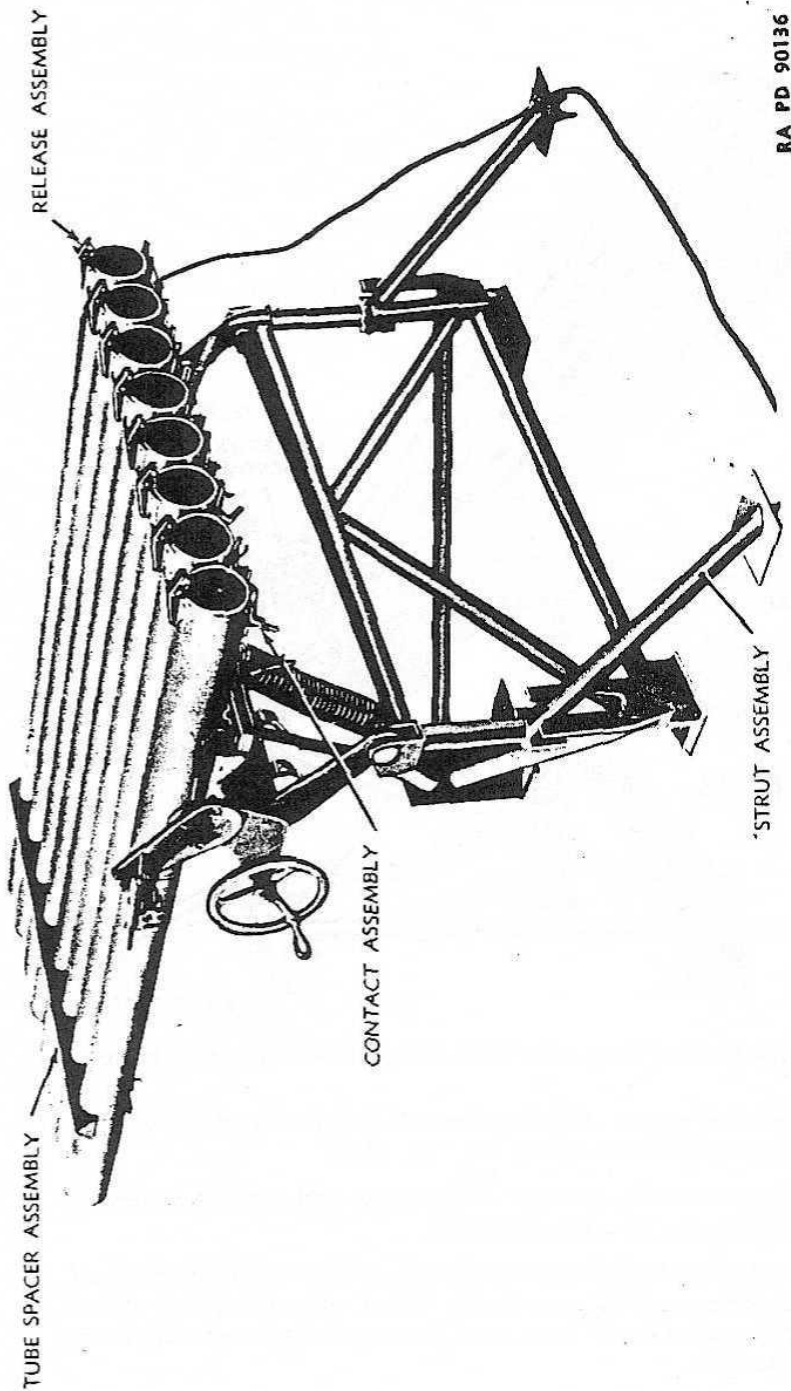

Figure 22—Rocket Launcher T27 Assembled—Tubes Horizontal



### OPERATION OF LAUNCHERS T27 AND T27E1 UNDER USUAL CONDITIONS

j. Insert plug on end of firing cord in socket marked "firing cord" on control box panel, and assemble coupling nut to socket (fig. 23).

k. Insert plug on end of generator cord in socket marked "generator cord" on control box panel, and assemble coupling nut to socket (fig. 23). Insert plug on other end in socket on back of generator. This plug has an arrow which must be aligned with arrow on generator before plug can be inserted.

l. Remove generator handle from spring clips on front of generator and insert in socket on right side of generator (fig. 23).

m. Check dial on control box to make sure that dial pointer is set at "0." If not at zero, remove safety plug from its socket used for storage and place it in socket marked "safety plug." Move safe key to "fire" position and check to see that reset key is in "reset" position. Crank hand generator fast enough to light dial lamp. While cranking generator, depress firing button in end of firing cord and dial pointer will reset to "0." Remove safety plug and replace safe key to "safe" position.

### 37. EMPLACEMENT OF LAUNCHER T27E1.

*NOTE: The Launcher T27E1 is identical to the Launcher T27 except that the mount can be disassembled by removing the tubular members which connect between the rear of the mount and the front foot, and that the strut assembly is shipped detached from the rear of the mount.*

a. The Launcher T27E1 is emplaced the same as the Launcher T27 outlined in paragraph 36 except as follows:

(1) Insert lower tubular members in their brackets on rear corner posts of left and right side of mount, insert bolts, assemble, and tighten nuts, and install cotter pins.

(2) Insert these members in their brackets on front foot, insert bolts, assemble and tighten nuts, and install cotter pins.

(3) Insert upper tubular members in their brackets on rear corner posts and front foot, insert bolts, assemble and tighten nuts, and install cotter pins.

(4) Remove clamps from end of strut assemblies by removing the four bolts. Position strut assemblies between U-brackets on the two corner posts at the rear of mount so that the bearing surface of the strut rests against the post. Aline holes in bearing surface of strut with holes in clamp and replace and tighten bolts.

(5) Assemble cradle assembly to the top rear of the mount by

4.5-INCH ROCKET MATERIEL FOR GROUND USE

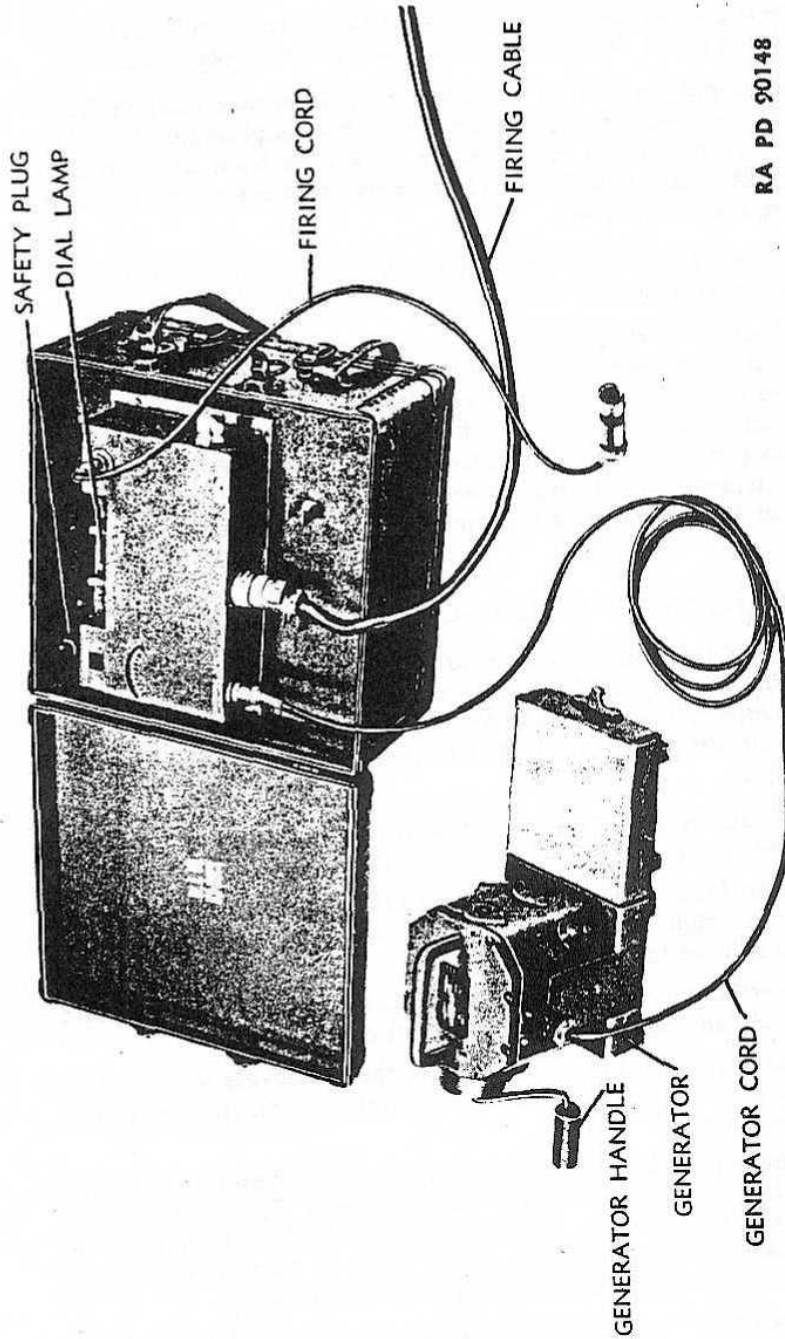

RA PD 90148

Figure 23—Firing Control Box and Generator Connected. Safety Plug and Safe Key in Safe Position

**OPERATION OF LAUNCHERS T27 AND T27E1 UNDER  
USUAL CONDITIONS**

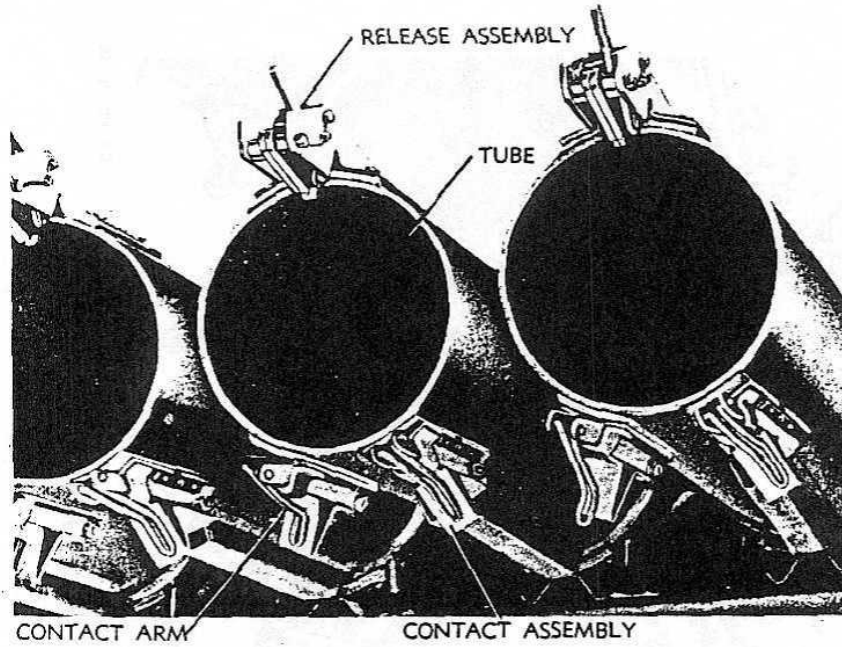

EARLY TYPE CONTACT ASSEMBLIES

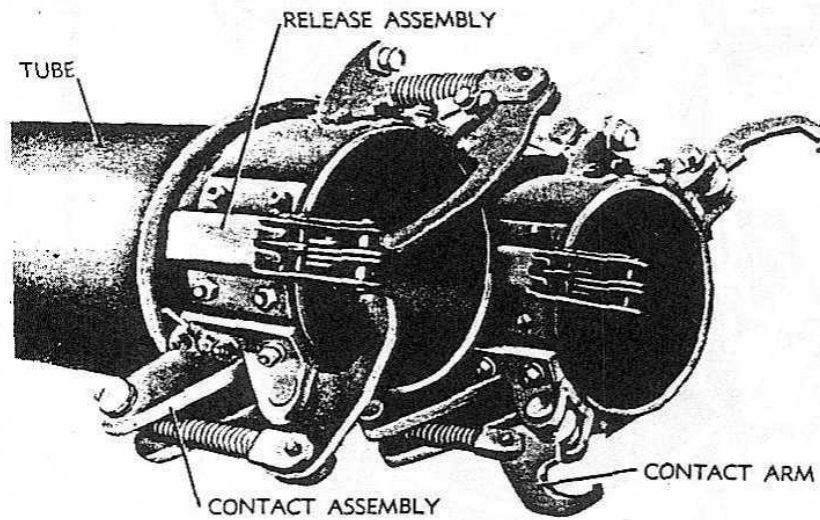

LATER TYPE CONTACT ASSEMBLIES

RA PD 91995

**Figure 24—Breech End of Launcher Tubes Showing Both Types of  
Contact Assemblies**

4.5-INCH ROCKET MATERIEL FOR GROUND USE

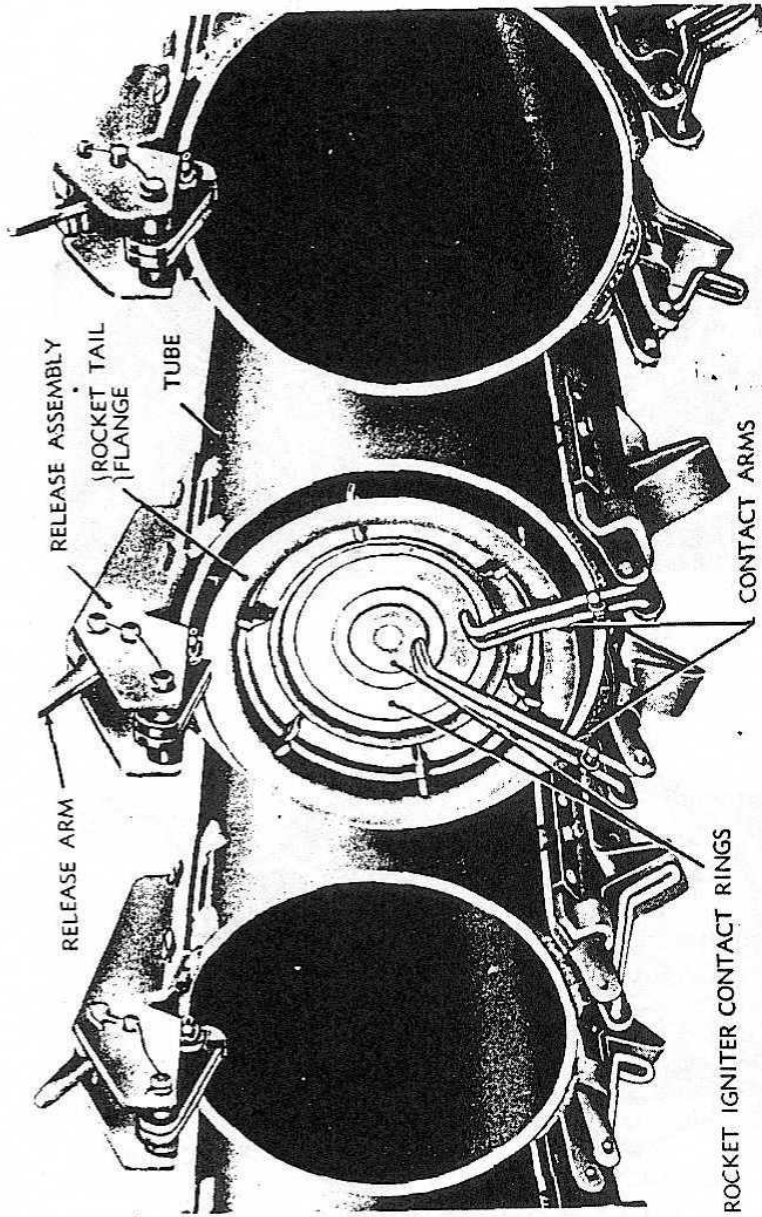

RA PD 90158

Figure 25—Breech End of Tubes Showing Rocket in Position

### OPERATION OF LAUNCHERS T27 AND T27E1 UNDER USUAL CONDITIONS

inserting the trunnions in the brackets. Insert bolts, assemble and tighten nuts, and install cotter pins.

(6) Position the elevating screw assembly in its bracket on the front foot, insert bolt, assemble and tighten nuts and install cotter pin.

#### 38. LOADING THE LAUNCHERS T27 AND T27E1.

a. *Be sure the safety plug is removed from its socket in the firing control box. This should be kept in the personal possession of the man in direct charge of the loading crew until the loading operation is finished.*

b. Turn all electric contact arms to open position. These arms should rest against the contact assembly attached to the rear outside of the launcher tubes (fig. 24).

c. Set rocket fuze as desired (SQ or delay) (par. 123 b) and remove safety pin.

d. Insert rocket in each tube from the rear, making sure slot in release latch engages the tail flange of the rocket (fig. 25). Remove the fin retainer from the rear of each rocket if time permits. This is not essential, but does eliminate the possibility of short-circuiting the contact arms.

e. Turn the contact arms down onto the contacts of each rocket igniter. Be sure tension is sufficient to insure good connections (fig. 25).

*CAUTION: If the rocket has a percussion primer in addition to the electric contact rings, do not let the contact arms snap down on the rear of the rocket, as the long contact arm may strike the primer and ignite the rocket, causing serious injury to personnel.*

#### 39. FIRING.

a. Make sure firing control box and hand generator are as far to the side of the launcher as the firing cable will permit. Make certain that personnel are out of range of the rearward blast of the rockets, at least 75 feet to the rear of the point of emplacement.

b. Personnel firing the launcher should wear helmets.

c. Insert safety plug in socket marked "safety plug" on control box panel (fig. 26).

d. Move safe key to "fire" position and move reset key to "fire" position (fig. 26).

4.5-INCH ROCKET MATERIEL FOR GROUND USE

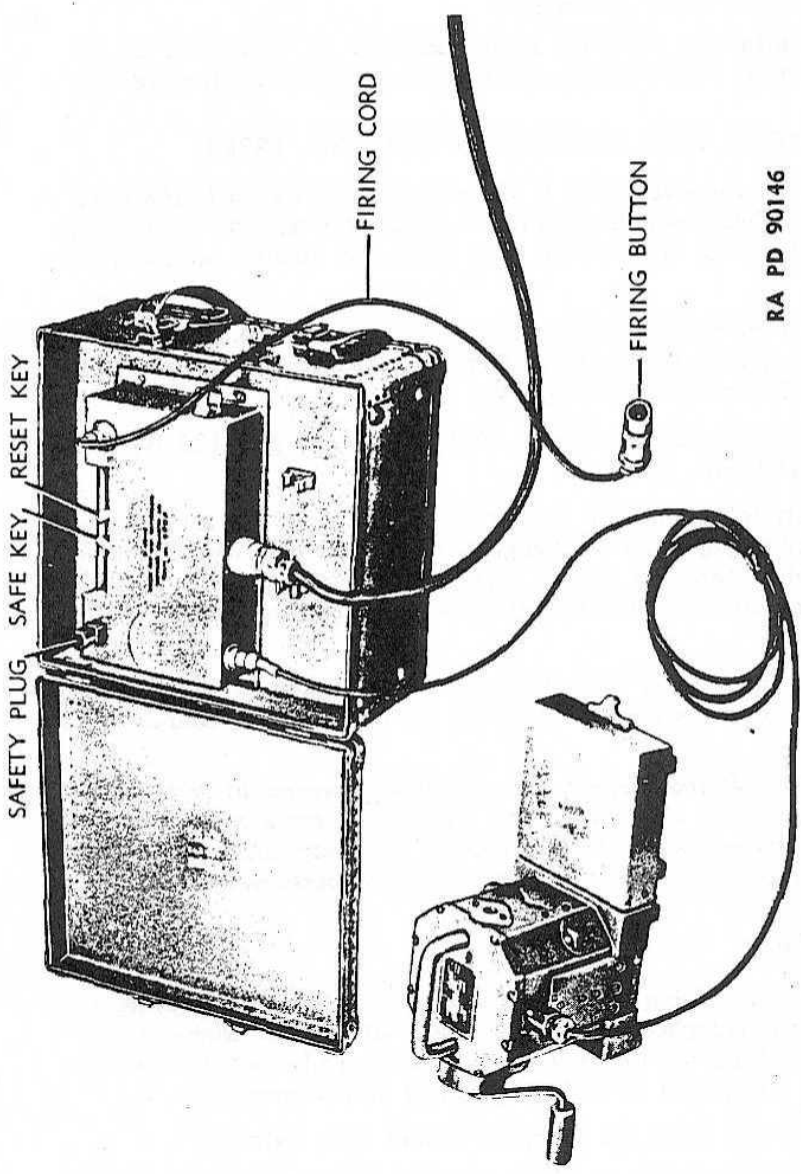

RA PD 90146

Figure 26—Firing Control Box Showing Safety Plug and Safe and Reset Keys in Firing Position

OPERATION OF LAUNCHERS T27 AND T27E1 UNDER  
USUAL CONDITIONS

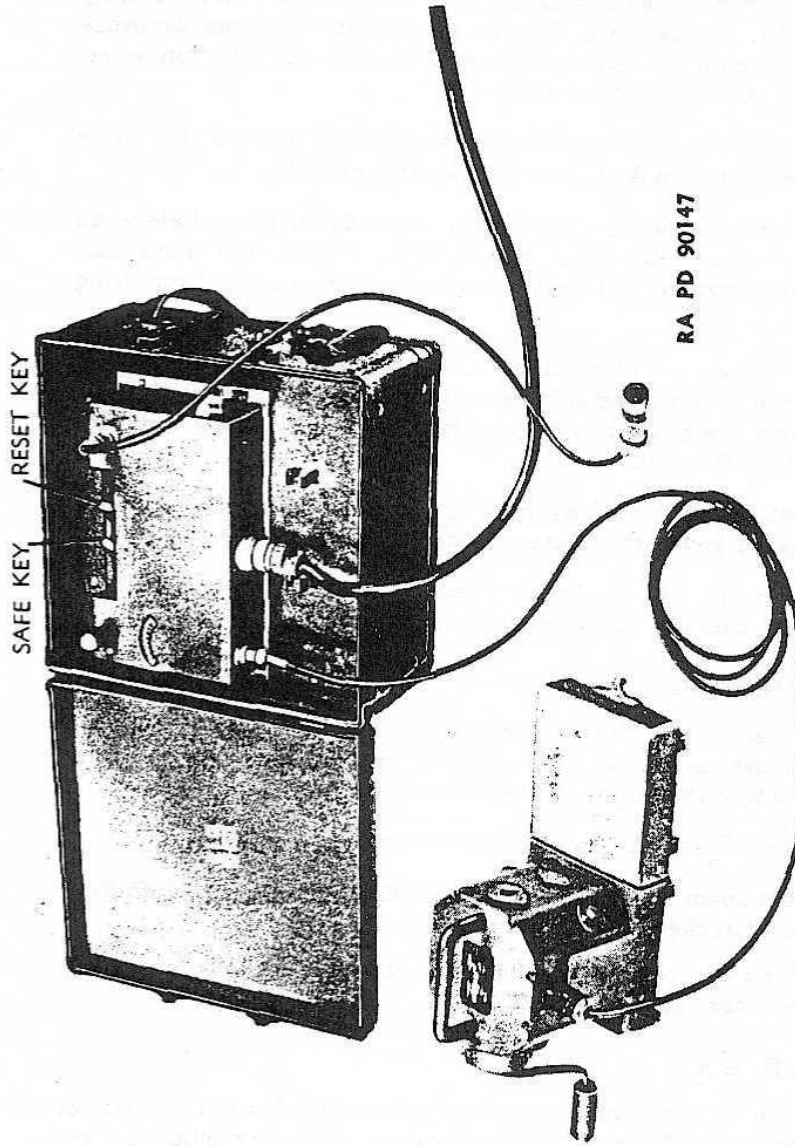

Figure 27—Firing Control Box Showing Safety Plug and Safe and Reset Keys in Reset Position



## TM 9-394

39-41

### 4.5-INCH ROCKET MATERIEL FOR GROUND USE

e. Crank hand generator with sufficient speed to illuminate red dial lamp on control box panel.

f. While cranking generator, depress firing button in end of firing cord (fig. 26). Rockets will then be discharged in proper sequence and at approximately 1/2-second intervals until firing button is released or all rockets have been fired.

g. If it is desired to fire rockets singly, depress firing button while generator is being cranked, and release immediately.

h. If it is desired to temporarily discontinue firing before all rockets have been discharged, release firing button and move safe key to "safe" position. Control of fire is then taken away from firing button.

i. The firing control must be reset after all rockets have been fired; however it can be reset before all rockets have been discharged, so that, when the firing button is pressed again, the firing sequence will start with No. 1 tube.

j. Reset firing control by moving reset key to "reset" position; while cranking generator depress firing button (fig. 27).

k. Move fire key to "safe" position, remove safety plug from "safety plug" socket and place it in socket used for storage.

#### 40. UNLOADING.

a. Be sure safety plug is removed from its socket. This should be kept in the personal possession of the person in direct charge of the unloading crew until the operation is finished.

b. Turn all electric contact arms to open position.

c. Press down and hold release arm which disengages latch from tail flange of rocket (fig. 25).

d. Withdraw rocket from the rear of the tube and replace safety pin in the rocket fuze.

#### 41. MISFIRES.

a. In the event that the rocket igniter explodes but the rocket is not fired out of the launcher tube, remove the safety plug from the firing control panel and wait 10 minutes before approaching the launcher. Then remove the rocket from the launcher tube, insert the safety pin in the fuze, and return the rocket to ordnance personnel for disposition as a defective round.



Section XII

**OPERATION OF LAUNCHERS T34 AND T34E1 UNDER USUAL CONDITIONS**

NOTE: *The Launchers T34 and T34E1 are issued mounted on the Medium Tank M4 series with all necessary connections made.*

**42. LOADING.**

a. *Be sure safety plug is removed from its socket on left side of firing control box (fig. 28). This should be kept in the personal possession of the man in direct charge of the loading crew until the loading operation is finished.*

b. Turn all electric contact arms to open position. These arms should rest against the contact assembly attached to the rear outside of the launcher tubes (fig. 29).

c. Set rocket fuze as desired (SQ or delay) (par. 123 b) and remove safety pin.

d. Insert rocket in each tube from the rear, making sure that slot in release latch engages the tail flange of the rocket (fig. 30). Remove the fin retainer from the rear of each rocket if time permits. This is not essential, but does eliminate the possibility of short-circuiting the contact arms.

e. Turn the contact arms down onto the contacts of each rocket igniter. Be sure tension is sufficient to insure good connection (fig. 30). CAUTION: *If the rocket has a percussion primer in addition to the electric contact rings, do not let the contact arms snap down on the rear of the rocket, as long contact arm may strike the primer and ignite the rocket, causing serious injury to personnel.*

**43. FIRING.**

a. Close all doors and hatches on tank for protection of personnel.

b. Make sure friendly troops are at least 75 feet behind tank.

c. Insert safety plug in its socket on left side of control box.

d. Make necessary adjustments in elevation, using controls for 75-mm gun.

e. Make necessary adjustments in azimuth, using controls which rotate the turret.

f. Move safe and reset keys to "fire" position. The indicating light will light, showing that the circuits are energized and ready for firing (fig. 31).

TM 9-394

43

4.5-INCH ROCKET MATERIEL FOR GROUND USE

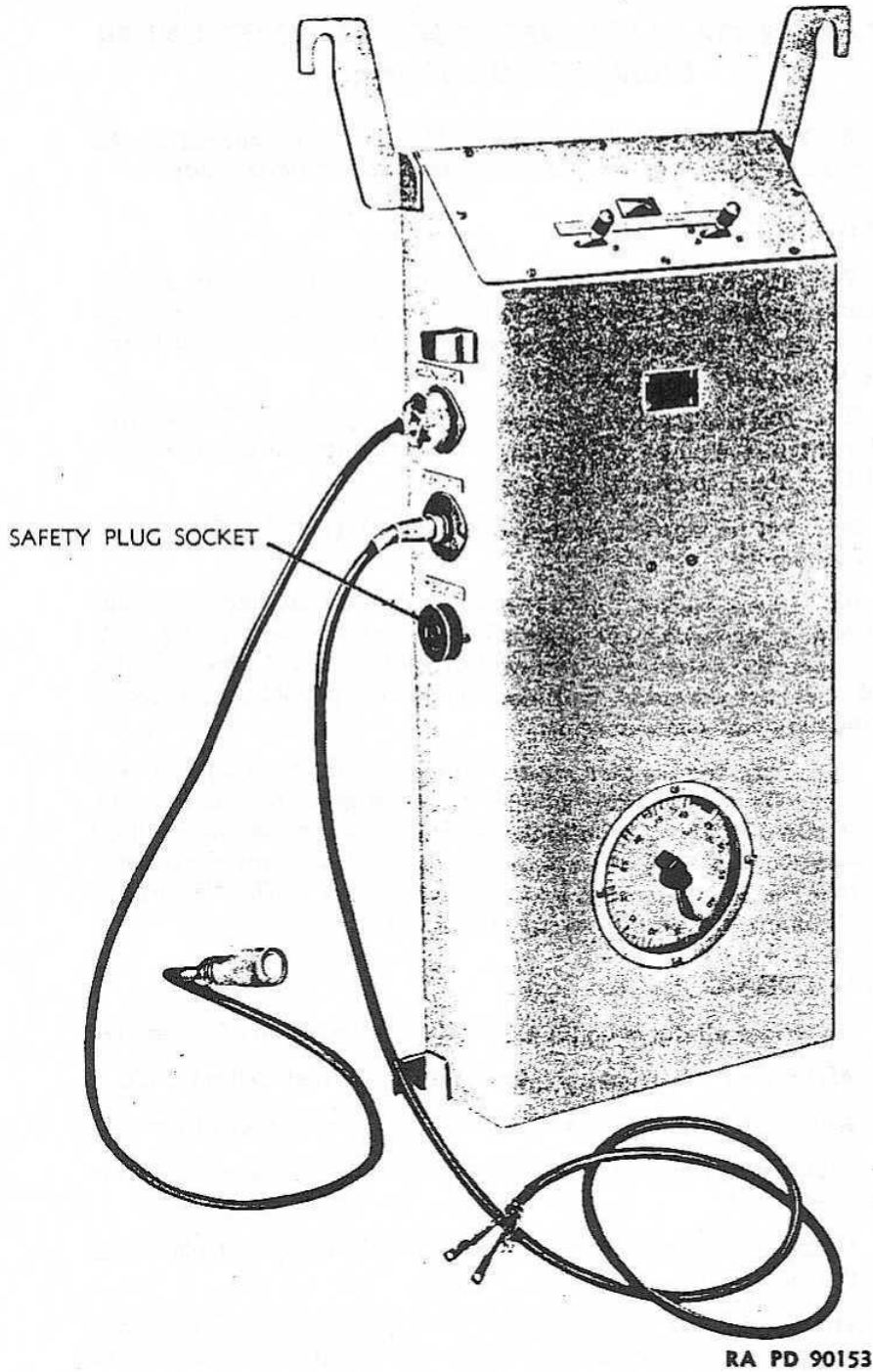

RA PD 90153

Figure 28—Firing Control Box Without Safety Plug

**OPERATION OF LAUNCHERS T34 AND T34E1 UNDER  
USUAL CONDITIONS**

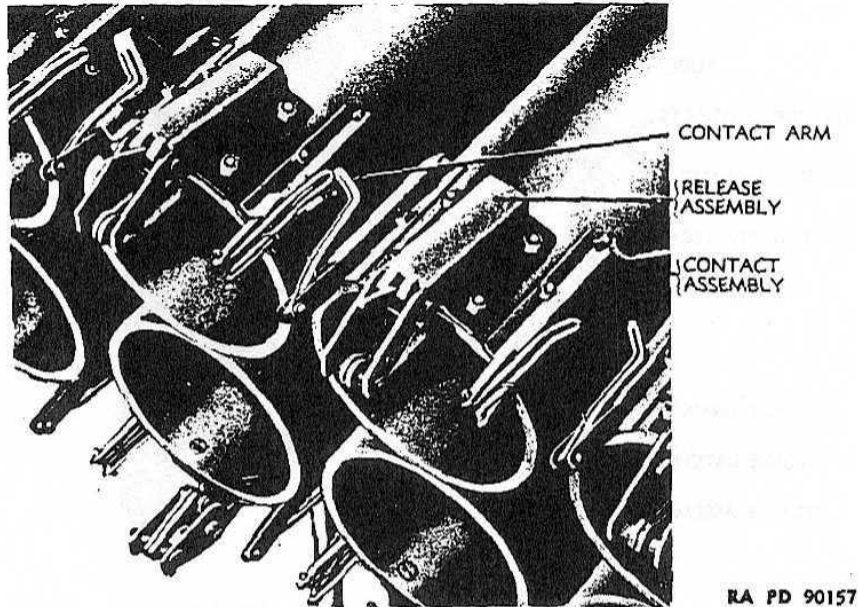

RA PD 90157

**Figure 29—Breech End of Launcher Tubes—Contact Arms in Open Position**

g. To fire single rockets press button in end of firing cord and release immediately (fig. 31).

*NOTE: The 75-mm gun should not be fired if a Launcher T34 is mounted on the tank.*

h. To discard rockets in ripple fire, press and hold button in end of firing cord. Rockets will be discharged in proper sequence and at approximately 0.5-second intervals as long as button is depressed or until all rockets are fired. When button is released, firing is stopped.

i. When firing button is released to discontinue firing, move safe key to "safe" position.

j. The firing control must be reset after all rockets have been fired, however it can be reset before all rockets have been discharged, so that, when the firing button is pressed again, the firing sequence will start with No. 1 tube.

k. To reset firing control, move reset key to "reset" position and safe key to "fire" position (fig. 32). The firing button need not be

## 4.5-INCH ROCKET MATERIEL FOR GROUND USE

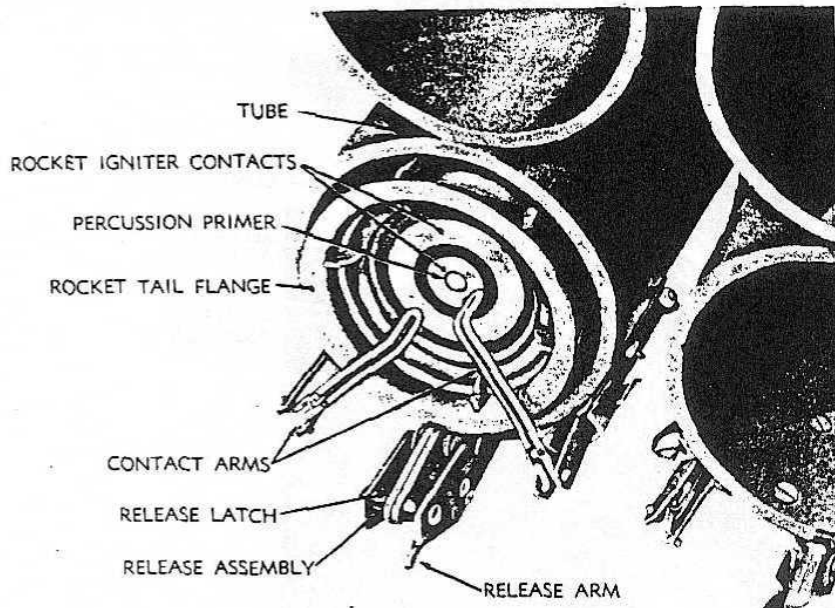

RA PD 90156

**Figure 30—Breech End of Launcher Tubes—Rocket in Position for Firing**

depressed. Firing control will automatically reset to zero with the safe and reset keys in this position. Remove safety plug.

l. The number of rockets fired is indicated on the selector switch indicator dial located on the front of the control box (fig. 13).

m. After the firing control has been reset, turn the knob on the circular window so that "0" aligns with dial pointer. The dial pointer remains stationary when the firing control is being reset.

#### 44. UNLOADING.

a. *Be sure safety plug is removed from its socket.* This should be kept in the personal possession of the person in direct charge of the unloading crew until the operation is finished.

b. Turn all electric contact arms to open position (fig. 29).

c. Press down and hold release arm which disengages latch from tail flange of rocket (fig. 30).

d. Withdraw rocket from the rear of the tube and replace safety pin in rocket fuze.

**OPERATION OF LAUNCHERS T34 AND T34E1 UNDER USUAL CONDITIONS**

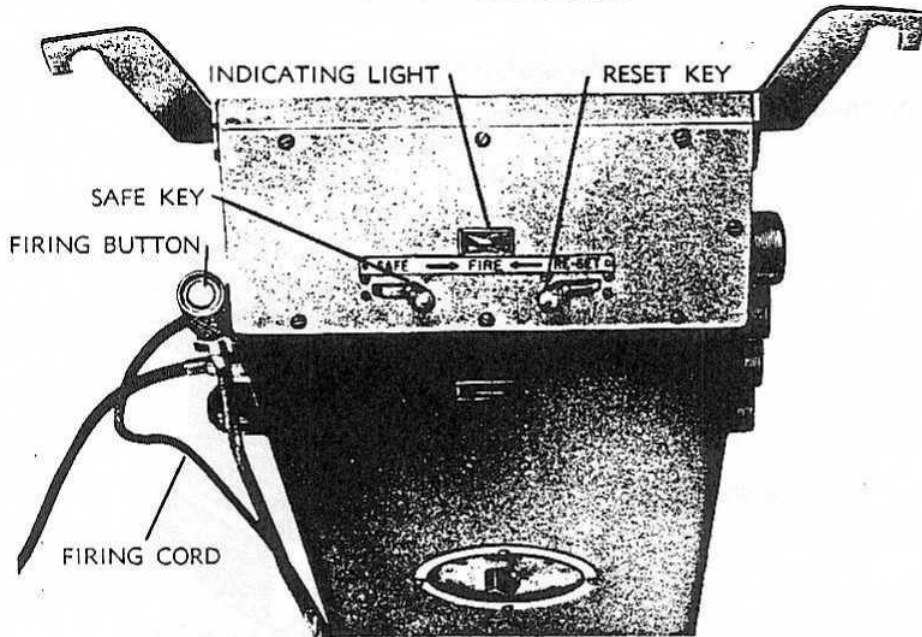

RA PD 90142

**Figure 31—Firing Control Box—Keys in Firing Position**

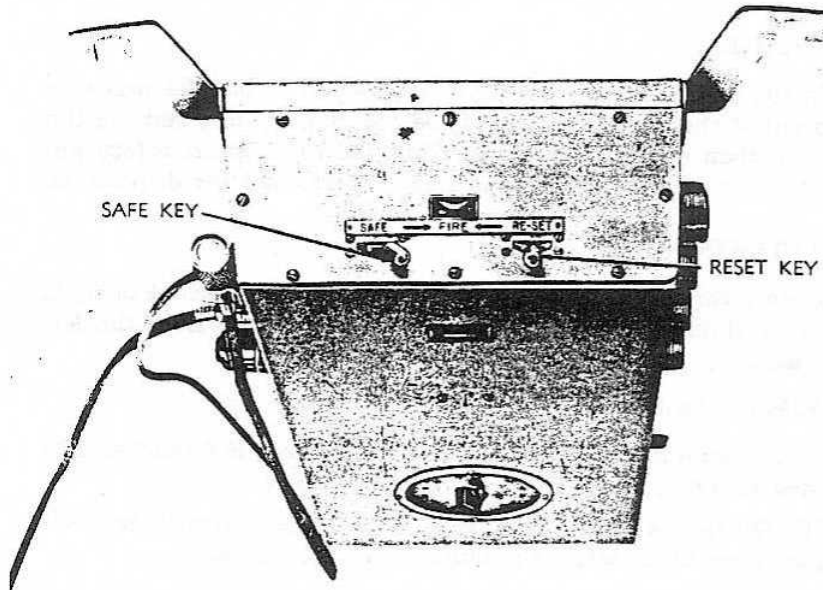

RA PD 90140

**Figure 32—Firing Control Box—Keys in Reset Position**

TM 9-394  
45-46

### 4.5-INCH ROCKET MATERIEL FOR GROUND USE

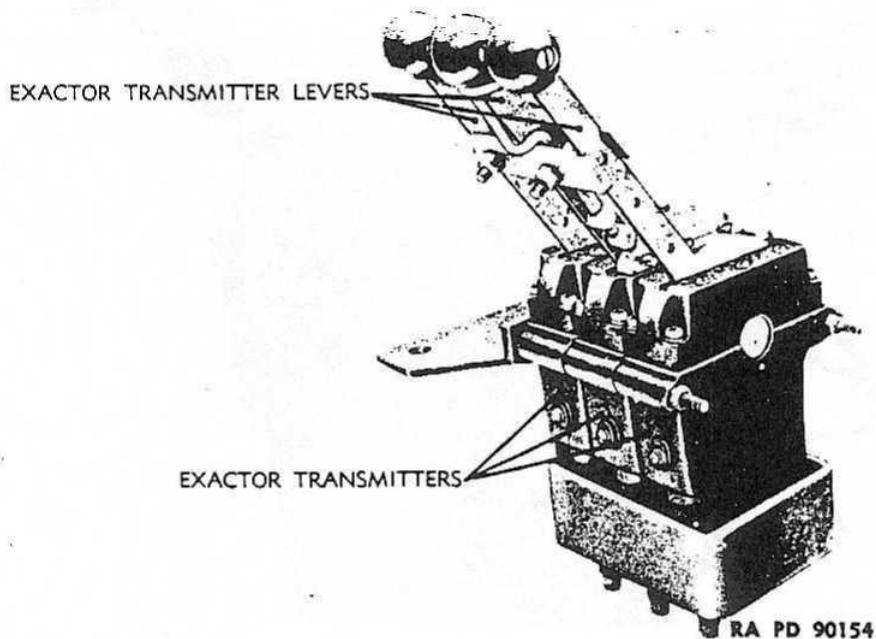

**Figure 33—Exactor Transmitter Levers in Rear Position**

#### 45. MISFIRES.

a. In the event that the rocket igniter explodes but the rocket is not fired out of the launcher tube, at the first opportunity remove the safety plug; then remove the rocket from the tube, insert safety pin in fuze, and return the rocket to ordnance personnel for disposition.

#### 46. JETTISONING.

a. Rotate the tank turret so that the tubes are crosswise of tank. It makes no difference whether the rear of the tubes is to the left or right side.

b. Elevate the launcher to the limit.

c. Grasp knife handle mounted on top of turret, if Launcher T34 is mounted on tank, and pull it, cutting the cables.

*NOTE: On the Launcher T34E1 the cables separate automatically at the periscope block when the launcher is jettisoned.*

d. Grasp exactor transmitter levers with both hands, lift latch on center lever if present, and pull levers from the front to the rear as far as they will go (figs. 14 and 33).

Section XIII

**OPERATION OF LAUNCHER T44 UNDER  
USUAL CONDITIONS**

*NOTE: The Launcher T44 is issued mounted in the 2½-ton, 6 x 6, amphibian Truck, GMC, DUKW-353, or by use of the Harness Adapter T2, in the Landing Vehicle, tracked (armored), Mk. IV, with all necessary connections made.*

**47. OPERATIONS PRIOR TO LOADING.**

a. Check the circular dial in the firing control box panel to make sure that both arrows are in line (fig. 15). If they are not, line them up as follows:

- (1) Remove cap from pedestal in upper right-hand corner of the firing control box panel.
- (2) Remove selector switch manual knob (one of the safety plugs) from its receptacle and insert it in the pedestal.
- (3) Press down on the knob and turn it so as to move the outer arrow until it comes in line with the inner arrow.
- (4) Remove the knob, place it in its receptacle, and replace the cap in the pedestal.

b. Set the selector switch indicator in the rectangular dial to "0" or any other setting desired. This setting is done as follows:

- (1) Operate the firing control box by depressing the "hold" and "fire" buttons.
- (2) Release the "fire" and "hold" buttons when "0", or the number before the one desired, comes opposite the red indicator mark.

*NOTE: This setting should be made only when the wiring harness is detached from the control box and before rockets are loaded into the launcher.*

c. Remove the two safety plugs from firing control box. These should be kept in the personal possession of the person in direct charge of the loading crew until the loading operation is finished.

d. Inspect and assemble the rockets (par. 125).

**48. LOADING.**

a. Stand on top of the launcher rack and to one side of the tube to be loaded.

b. Remove the shorting clip from rocket shroud.



4.5-INCH ROCKET MATERIEL FOR GROUND USE

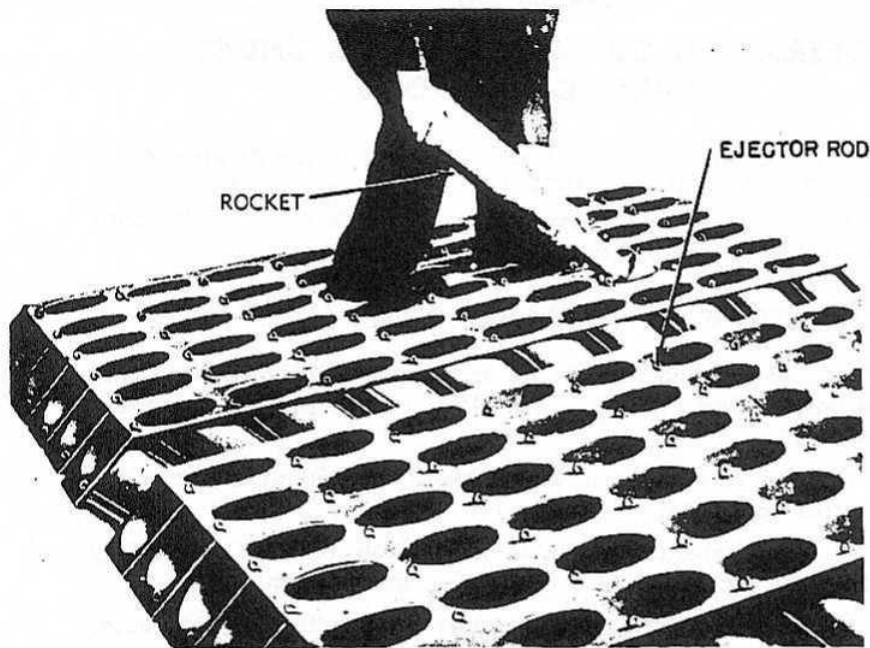

RA PD 50574

Figure 34—Inserting Rocket

- c. Remove the safety wire from the rocket fuze.
- d. Insert the rocket, tail downward, into the launcher tube (fig. 34). Hold the rocket by the fuze guard while lowering it into the tube. When at arm's length, release the rocket and allow it to slide down to the stop at the bottom of the tube.
- e. Because there may be some rebound when the rocket strikes the stop, use the special rammer to push the rocket down solidly against the stop. If this is not done, the shroud rings on the rocket may not touch the firing contacts and consequently a misfire may result.

49. PRECAUTIONS PRIOR TO FIRING.

- a. Make sure that the wiring harness is plugged into all rack sockets and into the firing control box and that the two-conductor feed wire is plugged into the socket on the dashboard and into the control box.
- b. Check the blast shield over the cab to see that it is in place and securely fastened down.
- c. See that all personnel are in the clear.



## OPERATION OF LAUNCHER T44 UNDER USUAL CONDITIONS

## 50. FIRING.

a. Insert the safety plug in its socket in the raised panel of the firing control box (fig. 15).

b. Turn on the master power switch. The indicating lamp will light, showing that the circuits are energized and ready for firing (fig. 15).

c. When ready to fire, push down and hold the "hold" and "fire" push buttons, using the index and middle fingers of the right hand. The motor-driven selector switch will start and run as long as the buttons are held down. This switch discharges current to the firing circuits of successive launcher tubes at intervals of one-half second, thus firing the rockets in ripple fire.

d. To cease firing, release the "fire" button by raising the index finger, but hold the "hold" button a moment longer to permit the electric braking circuit on the motor-driven switch to function. If both push buttons are released together, the switch arm may coast past the contact point connected to the next unfired rocket. Then when firing is resumed, that rocket will be missed and remain unfired.

e. To fire a single rocket at a time, operate the "fire" button while pressing the "hold" button.

f. If it is necessary to operate the selector switch manually, proceed as follows:

(1) Remove the cap which screws to the pedestal in the upper right-hand corner of the firing control box panel (fig. 15).

(2) Remove selector switch manual knob (one of the safety plugs) from its receptacle and insert it in the pedestal.

(3) Depress "hold" and "fire" buttons with left hand.

(4) While holding these buttons depressed, push down on selector switch knob and turn it slowly in a counterclockwise direction. This turns the contact switch arm and dial in the same direction as rotated by the motor. Firing speeds can be obtained which are approximately the same rate as obtained by the motor.

*NOTE: When dial is turned by hand it will be noticed that the arrow points, visible through round window, become displaced with relation to each other. This condition is characteristic of hand operation and gives visual evidence that contact arm has been rotated from last position to which it was brought by running the motor. This is of particular importance in case firing has been stopped before all rounds have been fired, because it definitely shows that the box has been disturbed since firing stopped. The arrows should be reset to aline them, so that firing would begin where it had left off and no unfired rounds would be left in the launcher.*

**4.5-INCH ROCKET MATERIEL FOR GROUND USE**

**51. UNLOADING.**

- a. *Remove the safety plugs from the firing control box and carry them until all ammunition has been unloaded from the launcher.*
- b. Insert the ejector hook in the eye of the ejector rod near the muzzle of the tube to be unloaded.
- c. Pull the ejector hook upward. The ejector rod can be pulled up about 4 inches, which is sufficient to clear the rocket shroud rings of the firing contacts.
- d. Reach into the launcher tube, grasp the fuze guard, and pull out the rocket.
- e. Inspect fuze to make sure it is not armed.
- f. Replace the fuze safety wire in the fuze.
- g. Replace the shorting clip on the rocket shrouds.

**52. MISFIRES.**

- a. If a misfire occurs, remove the round from the launcher at the first opportunity, following the instructions given in paragraph 51. Then make the following inspections:
  - (1) Inspect the rocket motor carefully to see whether the shorting clip had been removed. If not, remove the clip to eliminate the cause of misfire.
  - (2) Inspect the motor shroud rings for the scratch marks made by the firing contacts. If clear marks do not show up on both shroud rings, proper connection probably was not made; at the first opportunity, the contacts in the launcher tube should be inspected for possible damage by ordnance personnel.
  - (3) If possible, an attempt may be made to fire the misfired rocket from another tube of the launcher, in order to determine whether the difficulty is due to a faulty rocket motor or to a fault in the firing circuit of the tube.

---

**Section XIV**

**OPERATION OF LAUNCHER T45 UNDER  
USUAL CONDITIONS**

**53. EMPLACEMENT FOR FIRING LAUNCHER FROM THE  
GROUND (fig. 35).**

- a. Place base frame assembly on level ground.
- b. Place mounting lugs located on bottom of crutch assembly in front keyhole sockets on base frame assembly. Let crutch assembly rest against base frame.

## OPERATION OF LAUNCHER T45 UNDER USUAL CONDITIONS

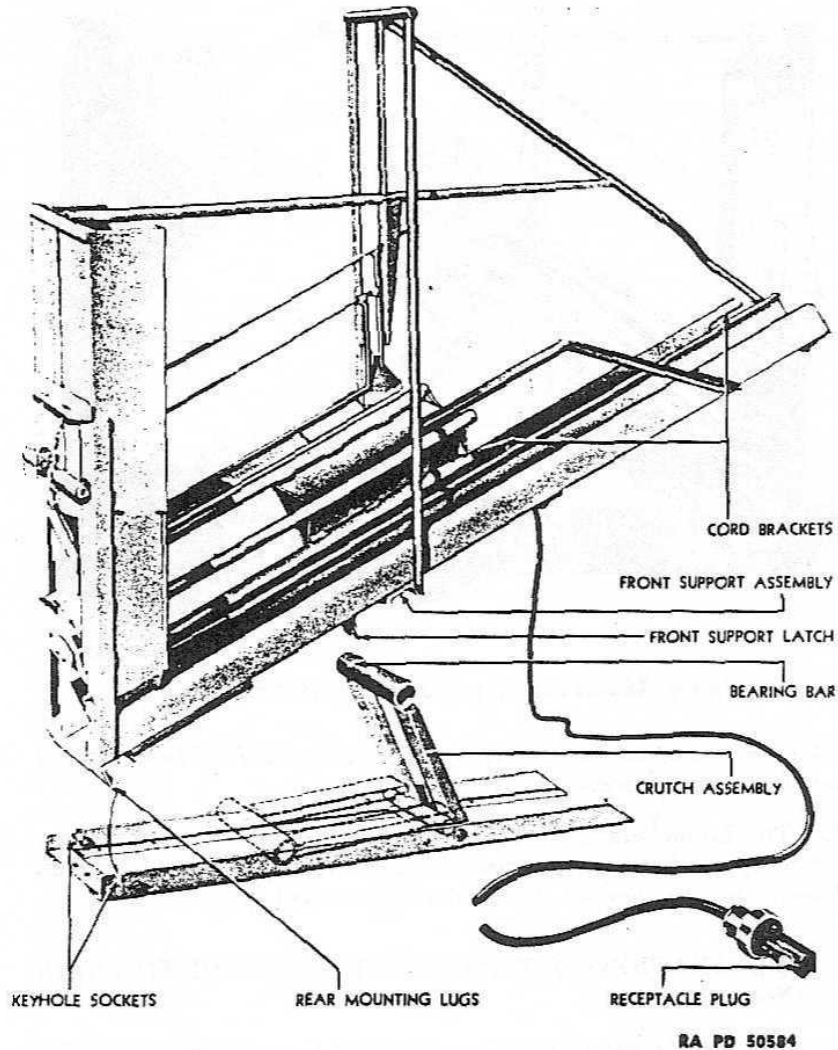

**Figure 35—Launcher Removed From Base Frame**

c. Place mounting lugs located on lower rear end of launcher in keyhole sockets on rear end of base frame.

d. Hold the front end of launcher up, rotate the crutch assembly upward, and seat bearing bar in the front support assembly.

e. Rotate front support latch around bearing bar, aline latch with bolt in support assembly, and tighten wing nut.

**NOTE:** *If the launcher is to be fired from a truck or other vehicle*

4.5-INCH ROCKET MATERIEL FOR GROUND USE

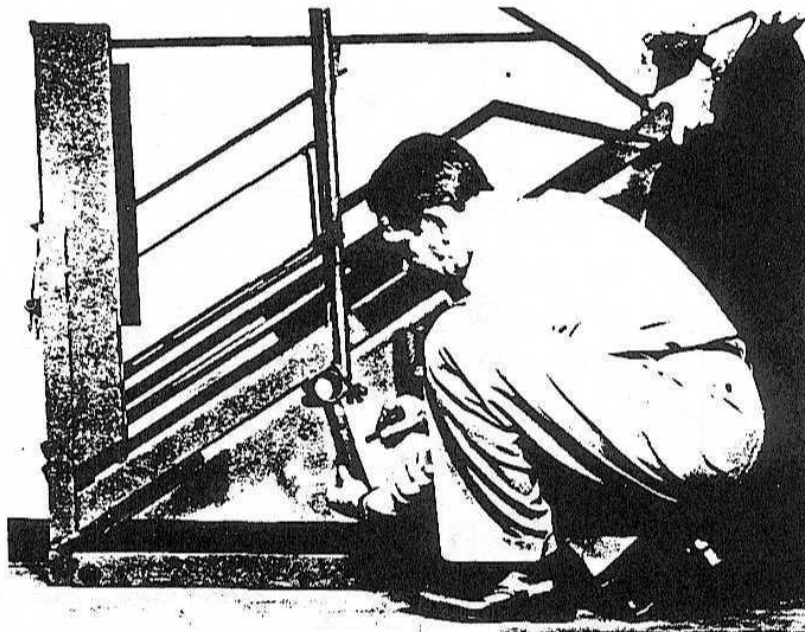

RA PD 50590

**Figure 36—Adjusting Elevation of Launcher**

*it will be mounted on the vehicle by ordnance personnel before being issued to the using arms.*

f. The Launchers T45 are generally issued in a battery of two, operated by one firing control box. Electrical wiring of these launchers will be made and checked by ordnance personnel.

**54. PREPARATIONS AND PRECAUTIONS PRIOR TO LOADING.**

a. *Remove the safety plug from the firing control box. (fig. 16).* This plug should be carried by the loader or other responsible personnel until such time as rockets are to be fired.

b. It is preferable to elevate or depress the launcher prior to loading, to save the unnecessary lifting of the heavy rockets (fig. 36.)

c. Make sure the launchers are properly aimed in elevation and in azimuth.

d. Draw the receptacle plug from launcher No. 1 to the junction box for launcher No. 1. Draw the receptacle plug from launcher No.

## OPERATION OF LAUNCHER T45 UNDER USUAL CONDITIONS

2 to the junction box for launcher No. 2, but do not connect the plugs at this time.

e. Make sure that the firing control box is connected to the source of power.

f. Inspect the rockets for bent or otherwise damaged fin assemblies. Do not use rockets with defective fin assemblies.

g. Inspect components and prepare complete rounds in accordance with instructions in paragraph 125. Remove the shorting clips. The fuze safety wires should not be removed until after the rockets have been loaded in the launcher. Because of the blast action to which rocket fuzes are subjected in this launcher, it is very important to make sure the fuze propellers are locked by the propeller lock pin.

### 55. LOADING.

a. **Precautions.** Make sure the safety plug is removed from the firing control box and the receptacle plugs disconnected from the junction boxes.

b. Place the gate in the latched position, that is, with the gate latches to the left of the table.

c. The first four rockets to be loaded into the launcher require special care as described in subparagraph d below. Rockets may be loaded into the launcher from either side or from the rear. Insert the forward end of the rocket between the center guide and either one of the front guides, depending on the magazine to be loaded, until the shrouds clear the rear guides. Figure 37 shows the loading of a rocket into the supply magazine. Lower rocket parallel to the launching rail until it comes to rest. The rocket should bear against the rear guide.

d. The first four rockets must be loaded in the following order (fig. 38):

(1) Lower the first rocket through the firing magazine until it rests against the reel, making contact with two reel rods throughout its length. Then allow the rocket to fall into the launching rail.

(2) Lower the second rocket into place so that it rests on the reel over the first rocket.

(3) Lower the third rocket into place and allow it to rest on top of the second rocket. *Pull the second and third rockets away from the gate.*

(4) Lower the fourth rocket into the supply magazine and allow

4.5-INCH ROCKET MATERIEL FOR GROUND USE

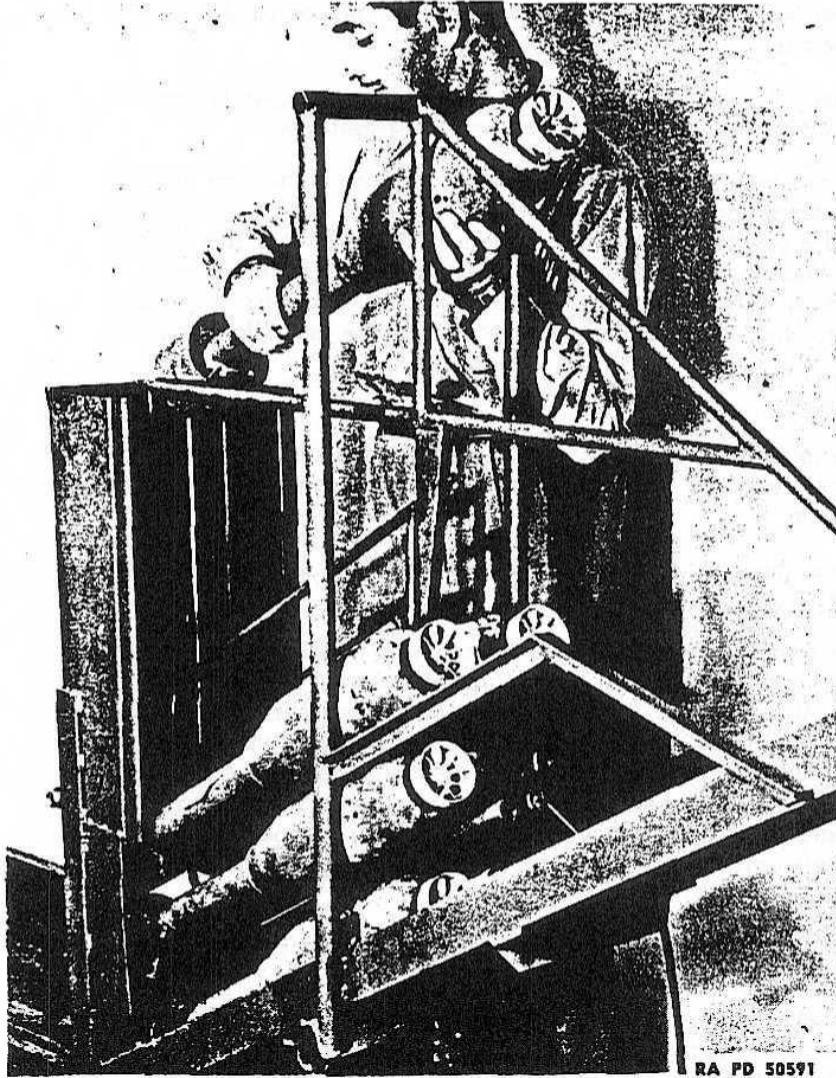

**Figure 37—Loading Launcher**

it to rest on the table. After this, rounds may be loaded in any order. The launcher is fully loaded when one rocket is in the launching rail, six rockets above the reel, and five rockets above the table.

(5) Make sure that the rear edges of the shrouds are back against the rear guide in each magazine.



OPERATION OF LAUNCHER T45 UNDER USUAL CONDITIONS

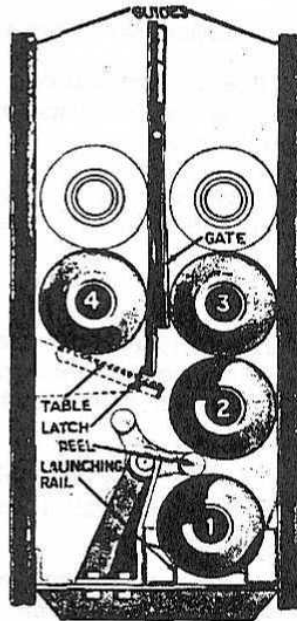

RA PD 50592

Figure 38—Sequence for Loading Launcher

56. PREPARATION PRIOR TO FIRING.

- a. Remove safety wires from rocket fuzes.
- b. Connect receptacle plugs from launchers to their respective junction boxes.
- c. Make sure that no personnel are within 75 feet of the rear of the launchers.
- d. Do not fire rockets below  $+10^{\circ}\text{F}$  or above  $+120^{\circ}\text{F}$ .
- e. Personnel in vicinity of firing should wear helmets.

57. FIRING.

- a. Place the safety plug in its receptacle in the firing control box (fig. 16).
- b. Hold the power button down. The firing pilot light should light, indicating electric power is available (fig. 16).
- c. To fire launcher No. 1, press firing button No. 1, and to fire launcher No. 2, press firing button No. 2, while holding the power button in the depressed position.

## TM 9-394

57-59

### 4.5-INCH ROCKET MATERIEL FOR GROUND USE

- d. To stop firing, release the firing buttons and the power button.
- e. Ripple fire will be obtained by holding the buttons down. Single-action fire will be obtained by depressing the firing buttons momentarily while holding the power button down.
- f. As soon as firing is completed, remove the safety plug from the firing control box, whether or not all rockets have been fired.

#### 58. MISFIRES.

a. Should a jam occur as a rocket is feeding from the magazine through the reel, it can usually be quickly corrected without unloading by prying up on the forward end of the rocket caught in the reel. *Remove safety plug first.*

b. In case a misfire occurs, attempt to fire by releasing and pressing power and firing buttons. If the misfire persists, wait 10 minutes before proceeding with the instructions below.

(1) Check to make sure that the shorting clips have been removed, that the shrouds of the rocket in the launching rail are not bent, and that the knife edge contacts in the launcher make contact with the shrouds. These contacts should cut through the paint on the shrouds and come into contact with the metal of the shrouds.

(2) Inspect the closure disk in the rear of the rocket. If it has blown out, the rocket is defective.

(3) If the rocket closure disk is intact, unload the launcher as described in the next paragraph, replace safety wire in fuze, and return the rocket, which would not fire, to ordnance personnel as a defective round.

#### 59. UNLOADING.

a. **Precaution.** Make sure that the safety plug is removed from the firing control box and that the receptacle plugs are disconnected from the junction boxes.

- b. Replace the shorting clips on the rocket shrouds.
- c. Replace the fuze safety wires in the rocket fuzes.
- d. Lift the rockets out of the supply magazine, one at a time.
- e. Lift the rockets out of the firing magazine, one at a time, except the rocket on the launching rail. This rocket should be removed last by sliding it forward on the launching rail until it clears the reel, then lifting it out.



Section XV

**OPERATION UNDER UNUSUAL CONDITIONS**

**60. GENERAL.**

a. Since rockets may not be fired outside their temperature ranges, operation under extreme temperature conditions is not permitted.

**61. EXCESSIVELY MOIST OR SALTY ATMOSPHERE.**

a. When the materiel is not in active use, the unpainted metal parts should be covered with a film of rust-preventive compound (light). The bore of the metal tubes should be kept oiled and all parts should be inspected daily for traces of the formation of rust. The materiel should be kept covered with tarpaulins as much as possible.

b. In excessively salty atmosphere, the oil or rust-preventive compound (light) used should be changed often as the salt has a tendency to emulsify the oil and destroy its rust-preventive qualities.

c. Check mounts frequently for chipped or cracked paint.

**62. EXCESSIVELY SANDY OR DUSTY CONDITIONS.**

a. If considerable sand or dust is present when the launchers are operated, the lubricant should be removed from the moving parts and these parts should remain dry until the action is over. If the surfaces are dry, there is less wear than when coated with a lubricant contaminated with grit.

b. Keep materiel covered with tarpaulins as much as possible.

c. Materiel must be cleaned frequently, as sand or dust and lubricant act as an abrasive.

**63. COLD CLIMATES WITHIN TEMPERATURE RANGES.**

a. Preparing a weapon for cold climate consists of inspecting and placing the launcher in good mechanical condition, cleaning, and lubricating with cold weather lubricants, and frequent exercising.

b. The materiel should be inspected to see that all moving parts operate freely and without binding.

c. In cold climates it is essential that all moving parts be kept absolutely free of moisture.

d. Clean and lubricate all parts, but do not use excess lubricant, because it may solidify to such an extent as to cause sluggish movement.

**TM 9-394**

**63-65**

#### **4.5-INCH ROCKET MATERIEL FOR GROUND USE**

- e. When launchers are in the open, cover with tarpaulins or other suitable material, if possible.
- f. When launcher and mount are transferred from the outside into a heated building, wipe dry with clean cloths and clean and oil metal parts immediately, to prevent condensation of moisture.
- g. Before applying the cold weather lubricants, the materiel should be thoroughly cleaned and all old lubricants removed.

#### **64. HOT CLIMATE WITHIN TEMPERATURE RANGES.**

- a. In hot climates, inspect and clean the launcher as frequently as required, rather than at fixed intervals.
- b. Where humidity is high, clean and oil as soon as possible after firing, when the launcher gets wet or dirty, or if there is any reason to expect corrosion to start.
- c. In temperatures above 90°F, summer grade greases and oils should be used as lubricants.

---

### **Section XVI**

#### **DEMOLITION TO PREVENT ENEMY USE**

#### **65. GENERAL.**

- a. The destruction of the materiel when subject to capture or abandonment in the combat zone will be undertaken by the using arm only on authority delegated by the division or higher commander, as a command function when such action is deemed necessary as a final resort to keep the materiel from reaching enemy hands.
- b. Adequate destruction of rocket materiel means damaging it in such a way that the enemy cannot restore it to usable condition in the combat zone, by repair or cannibalization. Adequate destruction requires that:
  - (1) Enough parts essential to the operation of the materiel must be damaged.
  - (2) Parts must be damaged beyond repair in the combat zone.
  - (3) The same parts must be destroyed on all materiel, so that the enemy cannot make up one operating unit by assembling parts from several partly destroyed units.
- c. The tubes and firing control box are the most vital parts of the 4.5-inch rocket launchers.

**DEMOLITION TO PREVENT ENEMY USE**

**66. DEMOLITION OF LAUNCHERS M12, M12A1, AND M12E2.**

a. Since both of these launchers are issued equipped with rockets, demolition should be as directed for ammunition in TM 9-1901.

**67. DEMOLITION OF LAUNCHERS T27 AND T27E1.**

a. Detach the sight. If evacuation is possible, carry the sight. If not, smash the sight thoroughly.

b. Remove safety plug and smash it, using butt end of rifle. Fire a few rounds of cal. .30 ammunition into the fire control box to destroy it.

c. Insert one Incendiary Grenade M14 midway in the center tube at 0-degree elevation. Ignite this grenade by inserting one other grenade, equipped with a 15-second safety fuze. Take cover, as the danger zone is at least 100 yards.

**68. DEMOLITION OF LAUNCHERS T34 AND T34E1.**

a. Thoroughly smash firing control box, using any available heavy tool in tank.

b. Jettison the launcher and drive over it with the tank crushing the tubes.

**69. DEMOLITION OF LAUNCHER T44.**

a. Thoroughly smash firing control box, using any available heavy tool from the DUKW or LVT.

b. Insert one Incendiary Grenade M14 in approximately the center tube of the fourth and eighth rack assembly. Ignite these grenades by inserting one other grenade equipped with a 15-second safety fuze in each tube. Take cover, as the danger zone is at least 100 yards.

**70. DEMOLITION OF LAUNCHER T45.**

a. Thoroughly smash firing control box, using any available heavy tool from the truck or LVT, or, if mounted on the ground, by firing a few rounds of cal. .30 ammunition into it.

b. Using a heavy tool, smash the knife-edge contacts and the contact box.

c. Smash or deform the reel and gate.

**TM 9-394**

**71-72**

**4.5-INCH ROCKET MATERIEL FOR GROUND USE**

**PART THREE—MAINTENANCE INSTRUCTIONS**

**Section XVII**

**GENERAL**

**71. SCOPE.**

a. Part three contains information for the guidance of the personnel of the using organizations responsible for the maintenance (1st and 2nd echelon) of this equipment. It contains information needed for the performance of the scheduled lubrication and preventive maintenance services, as well as description of the major systems and units and their functions in relation to other components of the equipment.

---

**Section XVIII**

**PREVENTIVE MAINTENANCE SERVICE**

**72. GENERAL.**

a. **Scope.** Preventive maintenance services prescribed by army regulations are a function of using organization echelons of maintenance. This section contains preventive maintenance service allocated to crew and scheduled preventive maintenance service allocated to organizational maintenance.

**b. Materials.**

BURLAP, jute

CLOTH, wiping, cotton

COMPOUND, rust-preventive,  
light

ENAMEL, synthetic, olive-drab,  
lusterless

OIL, lubricating, preservative,  
light

OIL, lubricating, preservative,  
special

SOAP, government issue

SODA ASH

SOLVENT, dry-cleaning

c. Dirt or grit, accumulated in traveling or from blast of piece in firing, settles on bearing surfaces and forms a cutting compound. Powder fouling attracts moisture and settles in operating grooves, preventing proper operation of moving parts, and hastens the formation of rust. It is essential that all parts be cleaned at frequent intervals, depending upon use and service.

d. If rust should accumulate, its removal from bearing surfaces requires special care in order that clearances shall not be unduly in-

**PREVENTIVE MAINTENANCE SCHEDULES**

creased. Crocus cloth should be used for this purpose. The use of coarse abrasives is strictly forbidden.

e. When materiel is not in use, suitable tarpaulins should be used as covers.

f. When materiel is not to be used for considerable time, all bright unpainted metal surfaces should be cleaned with dry-cleaning solvent and coated with rust-preventive compound.

---

**Section XIX****PREVENTIVE MAINTENANCE SCHEDULES****73. LAUNCHERS M12, M12A1, AND M12E2.**

a. As these launchers are expendable and should be discarded after the one round packed in the tube is fired, no maintenance is necessary.

**74. LAUNCHERS T27 AND T27E1.**

a. **Before Firing.** Before firing remove all rust-preventive compound from the release assembly and contact arms, using dry-cleaning solvent and clean dry burlap or wiping cloths. Before loading, wipe the tubes with clean, dry burlap or wiping cloths to insure that the tubes are clean and dry.

b. **After Firing.**

(1) After firing, swab the inside of the tubes to insure complete removal of powder residue and primer salts. Under no circumstances will the launcher remain without cleaning after it has been fired. Swab the tubes with a cleaning solution of one-half pound of soda ash to each gallon of water. Rinse with clean warm water. After drying thoroughly with jute burlap, apply a film of special preservative lubricating oil. If soda ash is not available, a soap sponging solution may be prepared by dissolving 1 pound of government issue soap in 4 gallons of water. The soap should be shaved from the bar to facilitate dissolving. It should then be added to water and the water heated until the soap is dissolved. The water should be stirred as quietly as possible to prevent foaming. To avoid the necessity of handling large receptacles, as much soap as is required for all the water to be used can be dissolved in one pail of water. This concentrated soap solution can then be added to water in other receptacles to make up the prescribed proportions. Special precautions must be

## TM 9-394

74-76

### 4.5-INCH ROCKET MATERIEL FOR GROUND USE

taken to rinse the tubes thoroughly before drying, because of the possibility of the soap leaving a gummy residue, and of corrosion from the presence of free caustic in the soap. In an emergency, water alone, preferably hot, may be used for cleaning. Repeat this procedure on three consecutive days thereafter, or until there is no evidence of sweating.

(2) Wipe the firing cable, generator cord, and firing cord clean of any dirt, grease, or other foreign material using clean, dry burlap or wiping cloths.

c. **Daily Service.** When the launcher is not being fired, clean out the tubes daily by thoroughly wiping with clean burlap, and apply a thin film of oil.

d. **Weekly Service.** Apply one or two drops of preservative lubricating oil (special) to the release assembly.

e. **External Parts of the Launcher.** When necessary, clean the rusted, pitted, and chipped exposed metal surfaces with crocus cloth, and repaint with olive-drab lusterless enamel (synthetic).

f. **If Used in Wet Weather.** Dry all electric contact points and exposed wires with a dry cloth. Clean and oil the rest of the launcher as described above.

### 75. LAUNCHERS T34 AND T34E1.

*NOTE: The tubes for the Launcher T34 are made of plastic, therefore, they need not be treated with rust-preventive compound.*

a. **Before Firing.** Before loading, remove all rust-preventive compound from the release assembly and contact assemblies, using clean, dry burlap or wiping cloths and dry-cleaning solvent. Remove all rust-preventive compound from the tubes of the Launcher T34E1.

b. **Weekly Service.** Apply one or two drops of lubricating preservative oil (light) to the release assembly.

c. **External Parts of the Launchers.** When necessary, clean the rusted, pitted, and chipped exposed metal surfaces with crocus cloth, and repaint with olive-drab, lusterless enamel (synthetic).

d. **If Used in Wet Weather.** Dry all electric contact points and exposed wires with a dry cloth.

### 76. LAUNCHER T44.

a. The Launcher T44 should have the same care as the Launcher T27 and T27E1, as outlined in paragraph 74.



## MALFUNCTIONS AND CORRECTIONS

### 77. LAUNCHER T45.

a. **Before Firing.** Inspect the live and ground contacts and remove all rust-preventive compound from them, using clean, dry burlap or wiping cloths and dry-cleaning solvent.

b. **After Firing.** Wipe the firing cable clean of any grease, dirt or foreign material, using clean dry burlap or wiping cloths.

c. **Weekly Service.** Apply a small amount of preservative lubricating oil (special) to the gate and reel bearings, front support hinge, screw, and spring.

d. **External Parts of Launcher.** When necessary clean the rusted, pitted, and chipped exposed metal surfaces with crocus cloth, and repaint with olive-drab, lusterless enamel (synthetic).

e. **If Used in Wet Weather.** Dry all electric contact points and exposed wires with dry cloths. Wipe the rest of the launcher with dry cloth.

---

## Section XX

## MALFUNCTIONS AND CORRECTIONS

### 78. LAUNCHER M12.

#### a. Failure To Fire.

(1) In the event contact is made and neither the igniter nor the rocket is fired, attempt a second contact with the battery or operate the exploder a second time. Make a third attempt, if necessary.

(2) In the event the rocket still does not fire, disconnect the exploder or battery and wait one minute before proceeding to the next step.

(3) Check all wires to see that there are no contacts with wet ground, no contact between bare wires and the ground, no broken wires, and no contacts between bare wires and the launcher legs. Correct all such defects and attempt to fire again.

(4) If, after the above, a salvo still does not fire, wait one minute, disconnect the launchers, remove the rockets, replace the safety pins in the fuzes, and set the launchers and rockets aside to be used separately rather than in salvos.

(5) If single rockets still do not function after checking the wiring, disconnect the battery or exploder and wait one minute, replace the safety pin in the fuze, and return the rocket and launcher to ordnance personnel for disposition.



**TM 9-394**

**79-81**

**4.5-INCH ROCKET MATERIEL FOR GROUND USE**

**79. LAUNCHERS M12A1 AND M12E2.**

**a. Failure To Fire.**

(1) Proceed as in paragraph 78 except that when the rocket is removed from the launcher tube the fuze must be removed.

(2) In the event a Launcher M12A1 or M12E2 has to be returned to ordnance personnel, the fuze will be repacked and resealed in the fuze container, but the fuze container will be kept separate and not replaced in the launcher tube.

**80. LAUNCHER T27.**

**a. Failure To Fire.**

(1) If contact has been made by pressing the firing button in the end of firing cord and neither the rocket nor igniter is fired, restore "safe" key to "safe" position and remove safety plug. Wait one minute before proceeding with the next steps.

(2) Check to see that the two contactors at the rear of each tube are turned down onto the two contacts on the igniter of the rocket. If clear marks do not show up on both contacts on the igniter, proper connection probably was not made and the contactors should be inspected for weak or broken springs or dirt, corrosion, or other foreign matter on the contact surfaces.

(3) Weak or broken springs should be replaced and dirty contact surfaces should be cleaned by scraping with a knife blade.

(4) Inspect all electric circuits to see that they are properly connected.

(5) Check all wires to be sure that insulation has not been worn off, that there are no contacts with wet ground, no contact between bare wire and the ground, no broken wires, and no contact between bare wires and the launcher. Correct any such defect by splicing broken wires together, taping uninsulated wires, and supporting wires on wet ground with dry sticks, dry stones, or any other available object which is dry and a nonconductor of electricity.

(6) If, after making the above examination, nothing is found out of order, restore "safe" key to "fire" position, replace safety plug, and attempt to fire rocket again. If rocket still does not fire, wait one minute, remove rocket from tube, replace safety pin in fuze, and return the rocket to ordnance personnel for disposition as a defective round.

**81. LAUNCHERS T34 AND T34E1.**

**a. Failure To Fire.** If a rocket does not fire from a tube, at the first opportunity proceed with the following steps:

### MALFUNCTIONS AND CORRECTIONS

- (1) Restore "safe" key to "safe" position and remove safety plug.
- (2) Check to see that the two contactors at the rear of each tube are turned down onto the two contacts on the igniter of the rocket. If clear marks do not show up on both contacts on the igniter, proper connection probably was not made and the contactors should be inspected for weak or broken springs or dirt, corrosion, or other foreign matter on the contact surfaces.
- (3) Weak or broken springs should be replaced and dirty contact surfaces should be cleaned by scraping with a knife blade.
- (4) Inspect all electric circuits to see that they are properly connected and that all plugs are firmly in their sockets.
- (5) The firing cables from periscope block are connected to the connectors on right side of control box. Make sure identifying letters on cables and connectors are the same.
- (6) Make sure firing cord is connected to proper outlet on left side of box (fig. 28).
- (7) Make sure 24-volt line from tank battery is connected to proper outlet on left side of box (fig. 28).
- (8) Check all wires to be sure that insulation has not been worn off, that there are no contacts between a bare wire and the tank, no contact between bare wires and the launcher, and no broken wires. Correct any such defect by splicing broken wires together and taping uninsulated wires.
- (9) If, after making the above examination, nothing is found out of order, remove the rocket, insert safety pin in fuze, and return the rocket to ordnance personnel for disposition as a defective round.

#### 82. LAUNCHER T44.

a. **Failure To Fire.** If a rocket does not fire from a tube, at the first opportunity proceed with the following steps:

- (1) Restore safe key to safe position and remove safety plug.
- (2) Remove rocket from launcher tube and replace safety pin.
- (3) Inspect the igniter lead-in wires for damaged insulation where they pass through the notches in the back of the rocket motor.
- (4) Inspect all electric circuits to see that they are properly connected and all plugs are firmly in their proper sockets.
- (5) The plastic plugs on the wiring harness assemblies are numbered from 1 to 12 and are attached to proper sockets on the front of tube rack assemblies. Tube rack assembly No. 1 is at the extreme left side and tube rack assembly No. 12 is at the extreme right side of body.
- (6) The three harness plugs are connected to contact plates on

**TM 9-394**

**82-84**

### **4.5-INCH ROCKET MATERIEL FOR GROUND USE**

rear face of control box. Both plugs and contact plates are numbered for identification.

(7) Check all wires to be sure that insulation has not been worn off, that there are no contacts between a bare wire and the DUKW or LVT, no contact between bare wires and the launcher, and no broken wires. Correct any such defect by splicing broken wires together and taping uninsulated wires.

(8) *If, after making the above examination, nothing was found defective, return the rocket to ordnance personnel for disposition as a defective round.*

#### **83. LAUNCHER T45.**

##### **a. Failure To Fire.**

(1) If contact has been made by pressing the power button and the rocket has not fired, remove safety plug and wait one minute before proceeding with the next steps.

(2) If the firing pilot light did not illumine when power button was depressed, indication is given that no electricity is passing through the control box. Check the connections to the source of power.

(3) If firing pilot light did illumine and the rocket did not fire, when the power button was depressed, it may be that electricity is not being supplied from the firing control box to the rocket.

(4) Check all wires to be sure that insulation has not worn off, and that there are no contacts between a bare wire and the launcher, vehicle, or ground. Correct any such defects by splicing broken wires together and taping uninsulated wires.

(5) If the rocket is jammed while feeding from the magazine through the reel, this can usually be corrected without unloading, by prying up on the forward end of the rocket caught in the reel.

(6) *If, after making the above examination, nothing was found defective, remove the rocket, insert safety pin in fuze, and return the rocket to ordnance personnel for disposition as a defective round.*

---

#### **Section XXI**

### **GROUPS COMPRISING LAUNCHERS M12, M12A1, AND M12E2**

#### **84. TUBE ASSEMBLY.**

##### **a. General.**

(1) The launcher tube is 4 feet long, made of plastic, and has a smooth bore. It is used to launch a 4.5-inch HE rocket. *NOTE: The tube for the Launcher M12E2 is made of magnesium alloy.*

## GROUPS COMPRISING LAUNCHERS M12, M12A1 AND M12E2

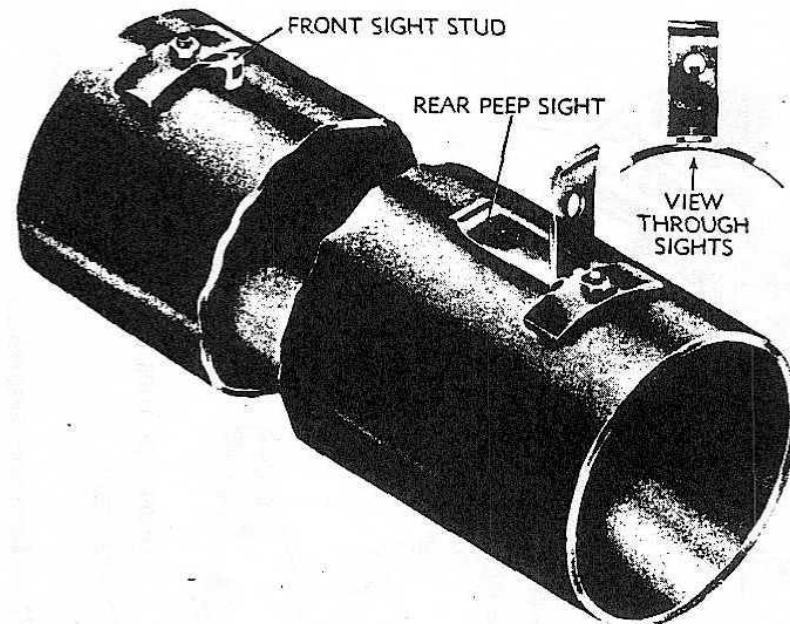

RA PD 50541

**Figure 39—Peep Sights on Launcher Tubes M12, M12A1, and M12E2**

(2) As issued, the launcher tube contains a 4.5-inch rocket. Strapped to the outside, is a folded tripod. Waterproof covers are provided on each end of the tube and spacer tubes are located in the muzzle and breech end. These spacer tubes prevent the rocket from shifting during transport and handling.

(3) Front and rear open sights are located on the top of some launcher tubes, while others have a folding rear peep sight and a fixed front stud instead (fig. 39). The folding rear peep sight is screwed to the back end of the launcher and rests against the launcher tube. A white line which is painted along the top edge of the launcher tube may also be used for sighting the launcher on the target.

(4) Launcher mounting supports, front and rear, are located on the tube. These consist of metal bands with brackets and are used for mounting the tube on the tripod mounting legs. The rear mounting support is fixed in place toward the back end of the tube, whereas the front support is adjustable and must be moved to the numbered position on the launcher tube to correspond with the numbered position on the mounting legs. These supports depend on the use of two small mounting cams (fig. 40), which are issued threaded on the packing straps of the launcher and tripod assembly.

4.5-INCH ROCKET MATERIEL FOR GROUND USE

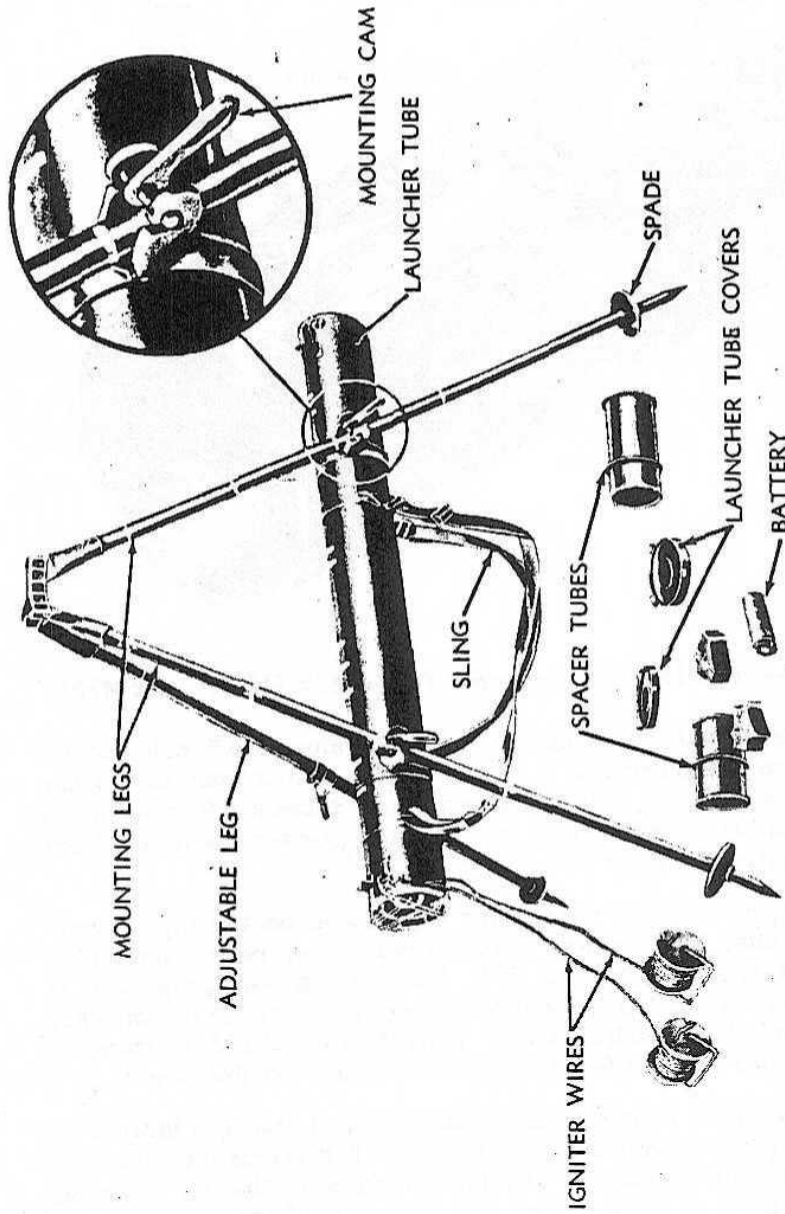

RA PD 50496

Figure 40—M12, M12A1, and M12E2 — Launcher Assembled

**GROUPS COMPRISING LAUNCHERS M12, M12A1 AND M12E2**

(5) Sling straps, front and rear, are also located on the tube. These consist of metal bands with brackets and are used for attaching the sling to the launcher tube.

(6) The numbered markings on the outside of the launcher tube correspond with those markings on the mounting legs of the tripod. The adjustable mounting support must be placed alongside the number which corresponds to the height that the launcher will be placed above the ground. The two supports will then be separated the proper distance to be supported at the desired elevation by the tripod.

**85. TRIPOD.**

**a. General.**

(1) The tripod is the means of supporting the launcher tube above the ground prior to firing. It consists of three legs hinged to a simple tripod head. Two of the tripod legs are fixed in length and are known as the mounting legs. The third leg is made adjustable by means of a telescopic portion and a clamp. The three legs are pointed and have, on their lower ends, a shoulder for support of spades which may be put on the legs when emplacing on soft ground. The mounting legs have graduations which indicate inches above the ground when the tripod is emplaced.

(2) Three leg spades are packed in the front section of the launcher tube. These spades should be attached to the legs in case the ground is muddy, sandy, soft, or marshy.

**86. FRONT SPACER TUBE.**

**a. General.**

(1) The front spacer tube located under the launcher tube muzzle cover, contains three leg spades for attaching to the tripod and a dry-cell battery used to fire the rockets.

(2) On the tubes of Launchers M12A1 and M12E2, this spacer also contains the rocket fuze in a fiber container (fig. 41).

**87. REAR SPACER TUBE.**

**a. General.**

(1) The rear spacer tube (fig. 41) under the launcher tube breech cover contains two spools, each containing 100 feet of wire.

(2) One end of the wire on each of the spools is attached to an igniter wire which is soldered to a contact ring on the rocket igniter. The other end of the wire on each of the spools is tinned and protrudes through a hole in the side of the spool. The loose end of



4.5-INCH ROCKET MATERIEL FOR GROUND USE

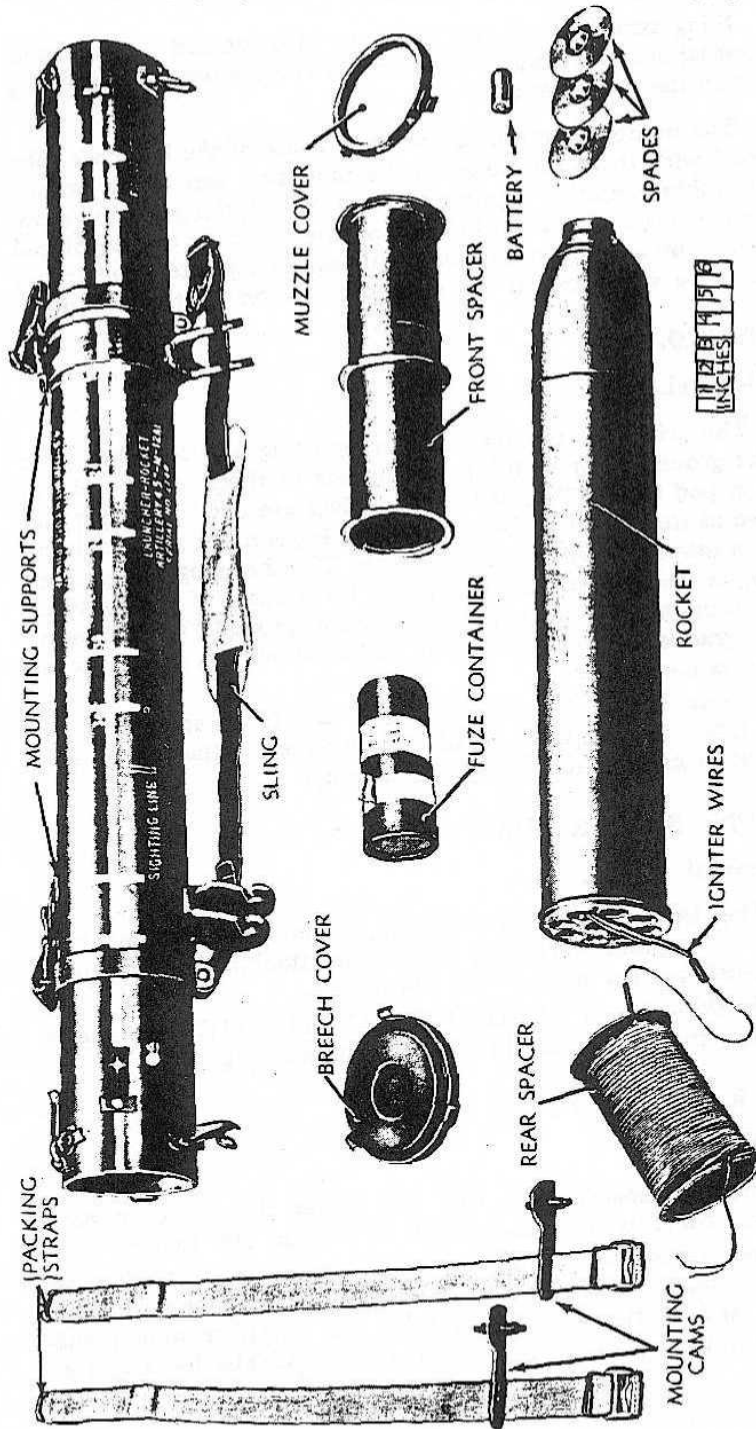

RA PD 85203

Figure 41—Contents of Launcher Tube M12A1 or M12E2



**GROUPS COMPRISING LAUNCHERS T27 AND T27E1**

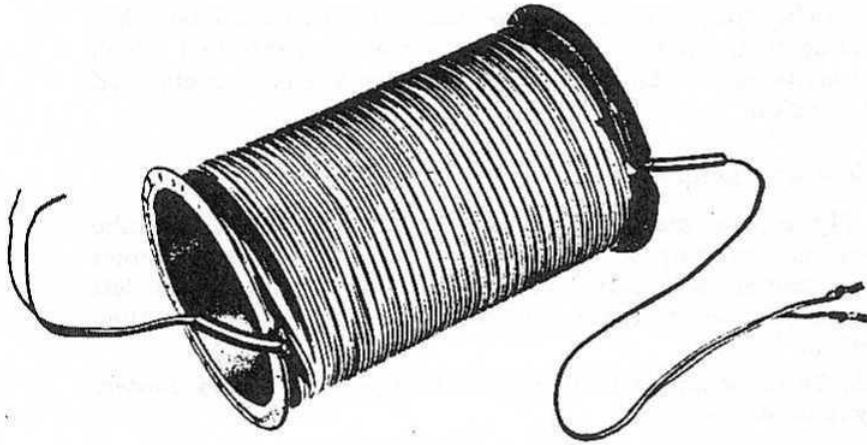

RA PD 90190

**Figure 42—Rear Spacer Tube Wound With Wire**

the wire is thus available without having to unwind the entire spool of wire. These wires are used to connect the rockets to a source of electricity and to connect rockets in parallel for salvo firing.

*NOTE: On launchers of present manufacture, the two spools, containing 100 feet of wire each, have been eliminated and the wire is wound around the outside of the rear spacer tube (fig. 42).*

**88. SLINGS.**

a. **General.** A pair of slings is provided to ease transportation of the launcher assembly.

---

**Section XXII**

**GROUPS COMPRISING LAUNCHERS T27 AND T27E1**

**89. TUBE ASSEMBLY.**

a. **General.** The launcher tubes are of steel, approximately 90 inches long, having an inside diameter of 4.5 inches. At the rear end of each tube are a release assembly and two contact assemblies. The release assembly engages the tail flange of the rocket and prevents it from sliding in the tube before being fired. The contact assemblies complete the electrical circuit to the rockets. Both are spring-loaded and have arms of proper length to reach the two contacts on the rocket igniter. About 18 inches forward of the rear end

4.5-INCH ROCKET MATERIEL FOR GROUND USE

of each launcher tube is welded a boss which mates with the launcher tube securing bolt. Slightly to the rear of this, is a terminal which touches a contactor on the cradle conduit, when the tube is clamped in firing position.

b. Contact Assemblies (fig. 24).

(1) The contact assemblies located on the bottom of the tube at the rear end are composed of a contact body, contact arm, contact arm spring, contact arm stop, and contact body insulator. The left contact assembly has a longer arm than the right; otherwise they are identical.

NOTE: *On launchers of later manufacture, a more sturdy contact assembly is used.*

(2) REMOVAL OF CONTACT ASSEMBLY (EARLY TYPE).

(a) The contact assembly should only be removed in order to replace broken or damaged parts.

(b) To remove unscrew the  $\frac{5}{16}$ -inch nut on the front end and remove contact wire. Replace nut on screw to prevent the loss of screw or spring.

(c) Remove the two bolts and nuts holding the contact assembly to the tube, using a  $\frac{5}{16}$ -inch double-head engineers' wrench 41-W-990, and close-quarter screwdriver, 1-inch blade, 41-S-1062, and remove contact assembly.

(3) INSTALLING OF CONTACT ASSEMBLY (EARLY TYPE).

(a) Aline holes in contact body with holes in tube. Insert screws through the tube, and through the insulator on the contact body, and replace nuts.

(b) Remove nut from screw at front end of contact assembly, replace wire and replace and tighten nut.

(4) ADJUSTMENT OF CONTACT ASSEMBLY (EARLY TYPE). If the contact arms are bent out of shape so that they do not make proper contact with the contact rings on the rocket (fig. 25), they should be bent back into shape, using combination slip joint pliers 41-P-1650, and taking care not to break the contact arms.

(5) MAINTENANCE OF CONTACT ASSEMBLY (EARLY TYPE).

(a) If the contact arm does not snap into position when lifted from its position against the body, indication is given that the contact arm spring is broken and should be replaced as follows:

1. Remove contact assembly as described in step (2) above.
2. Remove bolt and nut at front end of assembly; remove defective spring.

**GROUPS COMPRISING LAUNCHERS T27 AND T27E1**

3. Insert spring in bottom of contact body so that loop, on end which fastens to contact arm, points towards the top of body. Replace bolt in body and through loop on spring.

4. Grasp spring, pull towards rear end and snap it over pin welded to contact arm.

(b) If the contact arms are broken or bent beyond repair, they should be replaced as follows:

1. Remove contact arm spring from contact arm. It is not necessary to remove the bolt and nut from front end of assembly.

2. Using a pair of pliers 41-P-1650, bend one extension of contact body sufficiently to allow the arm to be withdrawn from its seat.

3. Replace new arm in its seat and bend extension of contact body back sufficiently to retain arm.

4. Hook loop of spring over pin on arm.

5. Replace contact assembly on tube as outlined in (3) above.

c. **Release Assembly (fig. 25).**

(1) The release assembly, located on top of the tube at the rear end, should be removed only for replacement when broken or defective. The assembly will be replaced as a unit.

(2) **REMOVAL OF RELEASE ASSEMBLY.** Unscrew the four holding screws and remove the release assembly from the tube.

(3) **INSTALLING OF RELEASE ASSEMBLY.**

(a) Aline four holes in release assembly with four holes in top of tube.

(b) Insert and tighten screws.

**90. MOUNT ASSEMBLY.**

a. **General.** The mount is for the purpose of holding the launcher tubes and is made principally of welded steel tubing. An elevating mechanism functions between the center of the cradle and the forward part of the mount. The mount is of rectangular shape at the rear, having a foot at each end. A tubular member from each corner of the rectangular portion of the frame converges at the front foot. A strut with a float and spade at the end is attached to each of the two corner posts at the rear of the frame. These struts are free to slide up and down and around the corner posts, hence may be swung out of the way inside the frame when not in use.

**91. CRADLE ASSEMBLY (fig. 21).**

a. **General.** Attached to the mount by means of two trunnions is the cradle assembly to which the eight steel launcher tubes are attached. The cradle is the means of moving the launcher tubes in

**TM 9-394**

**91-93**

#### **4.5-INCH ROCKET MATERIEL FOR GROUND USE**

elevation. The principal member of the cradle is a tube about 9 inches in diameter and approximately equal in length to the rectangular portion of the mount. At each end of this tubular member, a trunnion about 18 inches long is welded. These trunnions extend downward and each has a bearing at its lower end. It is by means of these trunnions that the cradle is secured to the mount. The cradle revolves on the bearings in the end of the trunnions when moved in elevation. At each end of the main tubular member is also welded a bracket for the elevating handwheel shaft. A sight bracket is bolted to the elevating handwheel shaft bracket at the left end. The telescope mount is bolted to the top of this bracket. At the center of the main tubular member are welded brackets for holding the elevating gear box. Along the top of the main tubular member is a welded steel tube support with a series of positions into which the eight launcher tubes are fastened parallel to each other. Beneath each launcher tube position and extending through the main tubular member is a launcher tube securing bolt with a lever handle. On the pivot end of each of these levers is a pawl which engages a stationary ratchet for the purpose of preventing accidental loosening of the tubes. Immediately behind the main tubular member of the cradle is a square conduit. On the top of this conduit are eight electric contacts. These complete the firing circuit to the launcher tubes when the latter are clamped in place. At the right end of the conduit is a connector for connecting the firing cable to the firing control.

#### **92. ELEVATING MECHANISM (fig. 21).**

a. **General.** The elevating mechanism which is used to elevate or depress the launcher tubes consists of a handwheel, handwheel shaft, gear box, elevating screw assembly, and equilibrator spring. The gear box is fastened between two brackets at the center of the cradle. The handwheel shaft extends from the gear box through the shaft bracket. The elevating handwheel is fastened to the shaft just outside the shaft bracket. Since there is a bracket on both sides of the cradle, the elevating shaft and handwheel may be assembled on either the right or left side. Normally, it will be mounted on the left side, as the sight bracket is on this side. The elevating screw assembly extends from the gear box to the front foot of the mount. The elevating screw is protected by a telescoping tubular housing. The equilibrator spring surrounds this housing.

#### **93. FIRING CONTROL (figs. 43 and 44).**

a. **General.** The firing control is used to fire the rockets. It is permanently mounted in a carrying case about 16 inches square and 9 inches deep having a cover on both sides. Under one cover is carried the firing cable and gunner's quadrant. The cable is 50 feet

## GROUPS COMPRISING LAUNCHERS T27 AND T27E1

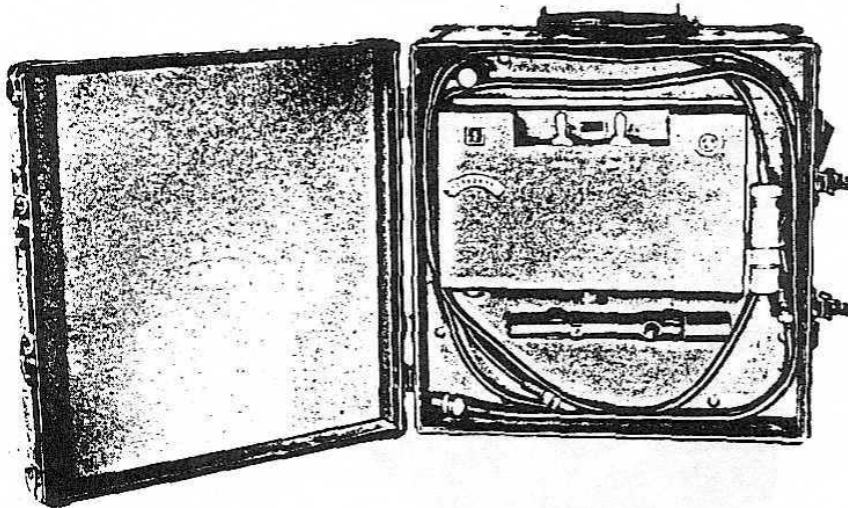

RA PD 90144

**Figure 43—Firing Control Case—Front View, Showing Contents**

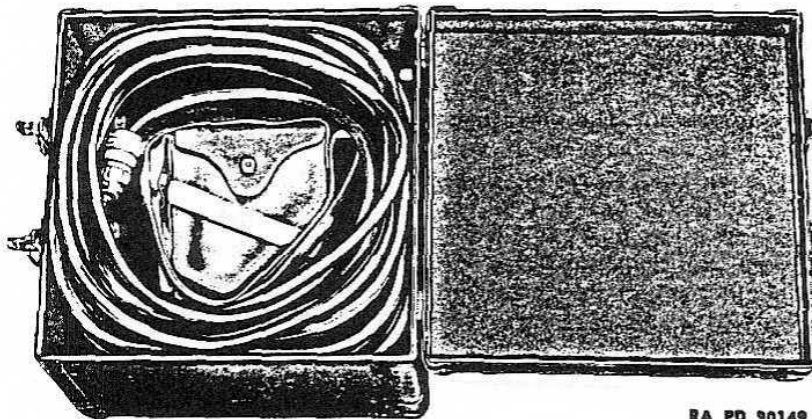

RA PD 90149

**Figure 44—Firing Control Case—Rear View, Showing Contents**

long and is used to connect the firing control to the launcher. Under the other cover is the firing control mechanism, firing cord, generator cord, and telescope sight. The firing mechanism has a safety plug, "safe" key, "reset" key, a socket for the firing cable, a socket for the firing cord, a socket for the generator cord, a dial with eight graduations, and a pointer which moves across the dial. The firing cord has

**TM 9-394**  
**93-95**

**4.5-INCH ROCKET MATERIEL FOR GROUND USE**

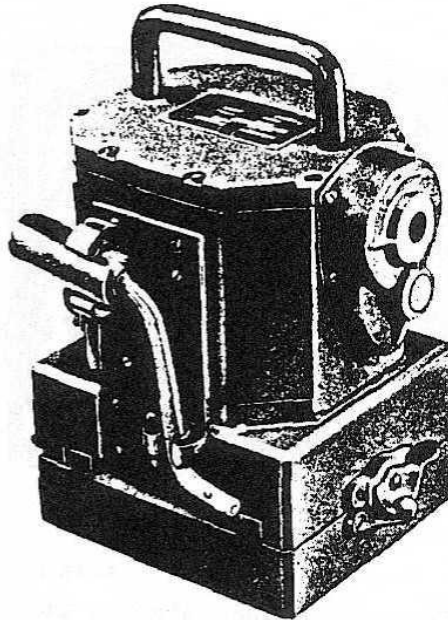

RA PD 90143

**Figure 45—Hand Generator**

a male plug on one end and a button on the other. The plug connects into its socket in the box and the button is used to control the discharge of the rockets. The generator cord has a male plug on both ends and is used to connect the generator to the firing control.

**94. HAND GENERATOR (fig. 45).**

a. **General.** The hand generator is approximately 9 inches high, 6 inches wide and 5 inches deep. It has a removable crank which is attached to the back of the generator, when not in use, by two spring clips. It provides the necessary electric current to the control box to fire the rockets.

---

**Section XXIII**

**GROUPS COMPRISING LAUNCHERS T34 AND T34E1**

**95. TUBE GROUP.**

a. **General.** There are three groups of tubes. The upper group contains 36 tubes and is made up of two layers of 18 tubes each. The lower right and lower left group each contains 12 tubes and is made up of two layers of 6 tubes. At the breech end of each tube



## GROUPS COMPRISING LAUNCHERS T34 AND T34E1

are two contact assemblies and a release assembly. The contact assemblies complete the electrical circuit to the rocket; the release assembly engages the tail flange of the rocket and prevents it from sliding in the tube before being fired. The tube group is held together by a channel iron frame and steel straps around each tube. Towards the rear of each side of the tube group is a trunnion. The outer ends of these trunnions are threaded and each is provided with a nut. A connection is provided in the front central portion of the tube group for attaching the elevating strut. An equilibrator spring is connected to each side of the launcher tube group at a point about 10 inches forward of the trunnion. The lower end of each equilibrator spring assembly is secured by the clevis on each trunnion support.

b. **Contact Assemblies** (fig. 29). The contact assemblies located at the rear end of the tube are identical to the contact assemblies on the Rocket Launchers T27 and T27E1 except that they do not have a contact body insulator. The removal, installing, adjustment, and maintenance of these should be made as outlined in paragraph 89 b.

c. **Release Assembly** (fig. 29). The release assembly located at the rear end of the tube is identical to the T27 and T27E1 release assembly. The removal and installing of this assembly should be done as outlined in paragraph 89 c.

### 96. TRUNNION SUPPORTS.

a. **General.** The trunnion supports are the primary means of connecting the tube group to the tank turret. They are about four feet long and of box construction. At the upper end of each trunnion support is the bearing for the tube group trunnion. It is about this trunnion that the tube group rotates in elevation. At the lower end of the trunnion support is the bearing for the trunnion pin bracket which is welded to the turret. The bearing is semicircular so that it may pull away from the trunnion pin bracket when jettisoning takes place. On the front edge of each trunnion support, a small rectangular piece of steel is welded. This projection bears on the under side of the fixed pin on the latch plate and prevents the trunnion support from rising off the trunnion pin bracket except when it is desired to jettison the launcher. Slightly above this projection is a clevis construction with latches securing the crosshead end (lower end) of the equilibrator spring. The equilibrator spring latches are connected by links to the jettisoning latches. The jettisoning latches are located on the outside of each trunnion support toward the rear edge and are so positioned as to hook over the swinging pins of the latch plates. The jettisoning latches are connected by links to the exactor receivers. The linkage and exactor receivers are so arranged that when



**TM 9-394**

**96-99**

**4.5-INCH ROCKET MATERIEL FOR GROUND USE**

the receivers are actuated they operate the jettisoning latches and the equilibrator spring latches, thereby releasing the trunnion supports from the trunnion pin brackets and the latch plates.

**97. ELEVATING STRUT.**

a. **General.** The elevating strut connects the forward end of the tube assembly with the 75-mm gun tube. Around the gun tube is clamped a split collar with a trunnion on each side. On the lower end of the elevating strut is a clevis construction with latches which engage the two trunnions of the split collar. These latches are actuated by an exactor receiver mounted about half way up the elevating strut. This receiver operates simultaneously with the two on the trunnion supports and is the means of disconnecting the elevating strut from the gun collar when jettisoning takes place. The upper end of the elevating strut is provided with a screw fitting which is used to adjust the tube assembly so it will be parallel with the gun tube.

**98. PERISCOPE BLOCK (LAUNCHER T34E1).**

a. **General.** The periscope block is a device which enables the firing cables and the three hydraulic lines to the exactors to separate quickly when the launcher is jettisoned. The lower part of the periscope block consists of three quick detachable couplings for the hydraulic lines and firing cable connectors clamped between two pieces of wood. The upper part of the periscope block consists of three short pieces of pipe and firing cable connectors clamped between two pieces of wood. At their lower ends the three pieces of pipe have the proper fittings to engage the quick detachable couplings and at their upper ends are connected to tubing leading to the exactor receivers. The lower part of the periscope block is positioned inside the tank and the upper part outside the tank. The upper part is connected to the launcher tube frame by a chain so it will be jerked out when the launcher is jettisoned.

**99. EXACTOR TRANSMITTERS (figs. 14 and 34).**

a. **General.** The exactor transmitters, located inside the turret, are operated manually by a member of the tank crew when it is desired to jettison the launcher. Three transmitters are fastened side by side and their levers are strapped together so that they must be operated simultaneously. On some transmitter assemblies the center lever is provided with a latch to prevent accidental operation.

**b. Filling Exactors.**

(1) The only maintenance authorized the using arms for the exactor transmitters is the filling of the exactors.

## GROUPS COMPRISING LAUNCHERS T34 AND T34E1

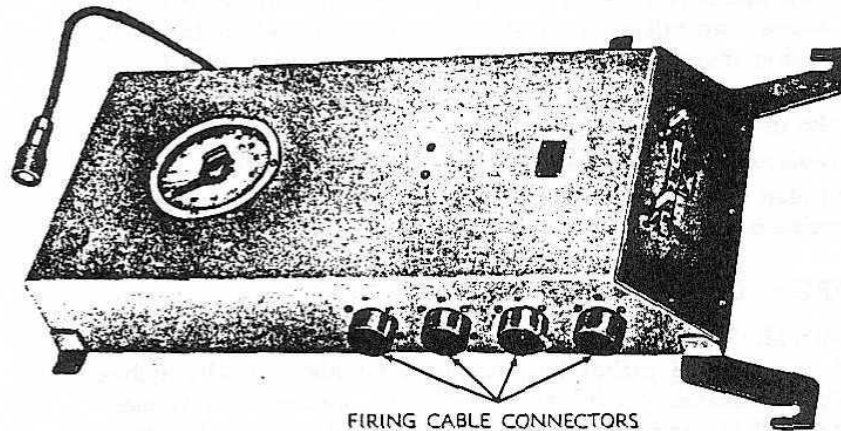

RA PD 90151

**Figure 46—Firing Control Box, Showing Firing Cable Connectors**

(2) Before attempting to fill the exactors the following operations must be performed:

- (a) Disconnect all links from receiver levers.
- (b) Wire all latches safely in place to prevent accidental jet-tisoning of the launcher.
- (c) Disconnect tubing from each of the three exactor receivers.
- (d) Remove strap which connects the three exactor transmitter levers.

(3) Remove knurled screw plugs from the tops of the three transmitters and fill each transmitter with Sperry Exactor Hydraulic Control Fluid "AH."

(4) Fill the line from each transmitter with fluid as follows:

- (a) Pull the operating lever of one of the transmitters to the rear.
- (b) Have a second man hold his finger over the end of the line attached to this transmitter while the lever is returned to its forward position. This motion draws the fluid from the reservoir into the cylinder of the transmitter.

(c) Keep end of line closed for about one second after completing the forward stroke. Open end of line and move lever to the rear again. This motion pumps oil from the transmitter into the line.

(d) Continue this procedure until line is entirely filled with fluid and bubbles of air do not emerge from the line.

(e) Be sure to fill transmitter reservoir each few strokes as its capacity is small. If this is not done, air is liable to be pumped into the line.

#### 4.5-INCH ROCKET MATERIEL FOR GROUND USE

(f) When line is full of fluid and free of all air, connect it to the receiver. Move transmitter lever slowly to the rear while this connection is being made to prevent air from being drawn into line.

(g) After connection is tightened, move transmitter lever to see if full stroke of lever is obtained.

(h) Replace knurled screw plug on top of transmitter.

(i) Proceed to fill and connect lines from each of the remaining two transmitters in the same manner.

#### 100. FIRING CONTROL (fig. 13).

a. General. The firing control is used to fire the rockets. It is contained in a box 23 inches high, 10 inches wide and 3½ inches deep, which is located inside the turret. This control box is electrically operated, current being supplied by the tank electrical system.

b. On the right side of the box are four connectors, designated A, B, C, and D, which connect the firing cables from the launcher tubes to the firing control (fig. 46).

---

### Section XXIV

#### GROUPS COMPRISING LAUNCHER T44 WHEN MOUNTED IN 2½-TON, 6 x 6, AMPHIBIAN TRUCK, GMC, DUKW-353

#### 101. TUBE RACK ASSEMBLY.

a. General. Each tube rack assembly consists of ten 5-foot tubes from which the rockets are launched. Twelve of these assemblies are lined side by side in the cargo space of the vehicles, thereby making up the complete battery of 120 tubes. All the tubes of each rack are arranged in line and are fixed at an elevation of 45 degrees.

(1) The base of each tube is equipped with live and ground contacts for completing the electrical firing circuits to corresponding shroud lines on the tail of the rocket.

(2) A toggle clamp located on the front and rear of each rack firmly secures the racks to the cross beam assemblies (fig. 47).

(3) The bottom ends of the 10 tubes which make up a rack, vent into a common trough running along the bottom of the rack. This trough carries the rocket blast gases and flame to the rear of the rack assembly, where they are discharged into a curved flame deflector at the rear end of the cargo space of the DUKW. Additional

**GROUPS COMPRISING LAUNCHER T44 WHEN MOUNTED IN  
2½-TON 6 x 6 AMPHIBIAN TRUCK, GMC, DUKW-353**

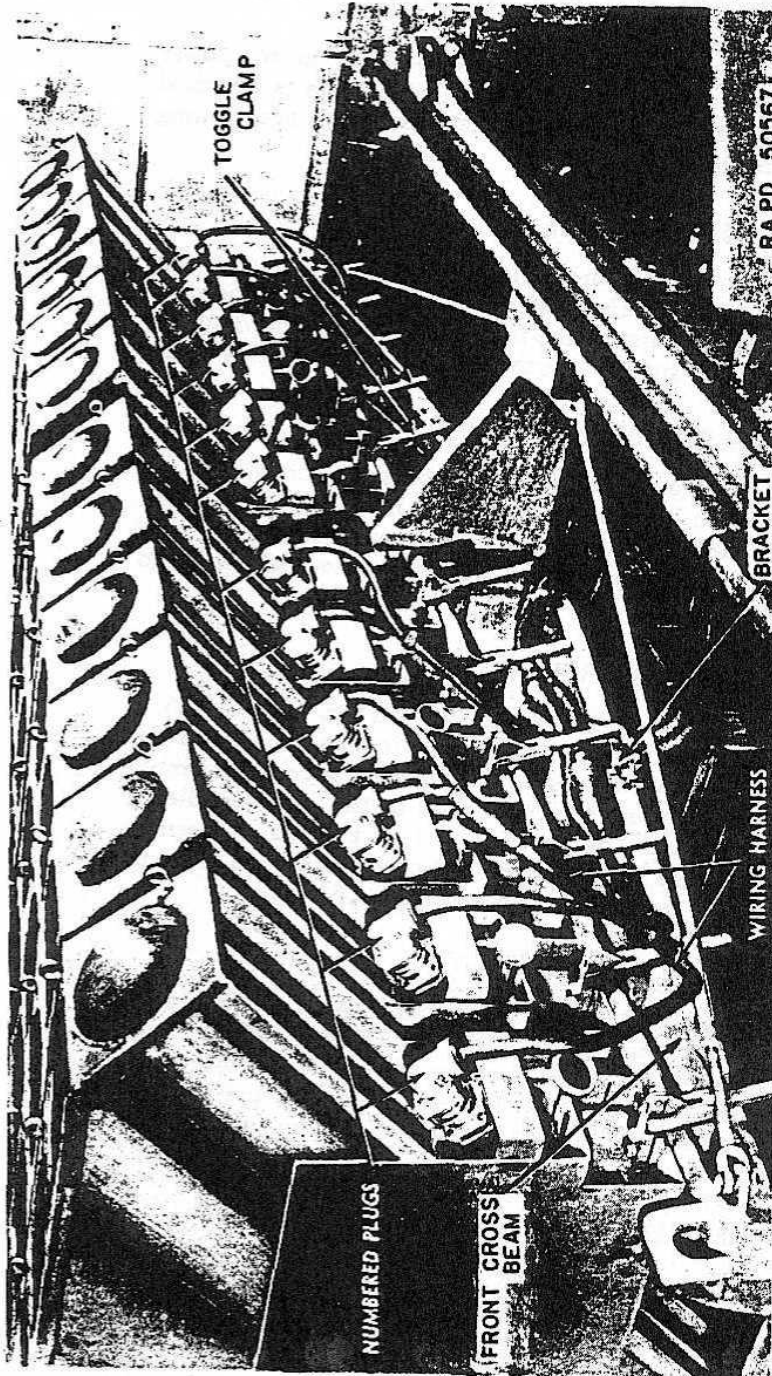

**Figure 47—Close-up of Wiring Harness**

**TM 9-394**

**101-106**

### **4.5-INCH ROCKET MATERIEL FOR GROUND USE**

relief for the blast gases is provided by perforations in the lower portion of the launcher tubes. A light metal baffle plate is attached to the right side of each rack to prevent blast gases from overheating the rockets loaded in the adjacent rack.

#### **102. CROSS BEAM ASSEMBLIES.**

a. **General.** Two cross beams (fig. 47), one to the front and one to the rear of the 12 racks, rest on the cargo space coaming. These beams position and support the tube racks. Struts and diagonal braces provide additional support for the cross beams and tube racks.

#### **103. FLAME DEFLECTOR ASSEMBLIES.**

a. **General.** Four flame deflector assemblies are located on the floor of the cargo space behind the launcher. Each is wide enough to accommodate the blast troughs from three racks. The purpose of the deflectors is to direct the blast gases upward and out of the cargo space.

#### **104. WIRING HARNESS ASSEMBLY.**

a. **General.** The wiring harness assembly (figs. 47 and 48) is the electric wiring system which connects the launcher tubes to the firing control box. The launcher end of the wiring harness assembly consists of 12 numbered plugs for connection to the correspondingly numbered launcher racks. The forward end of the wiring harness assembly consists of three numbered plugs for connection to the correspondingly numbered firing control box sockets (fig. 48).

#### **105. DRIVERS' SHIELD ASSEMBLY.**

a. **General.** The drivers' shield assembly (fig. 7) is a removable sheet metal shield which protects the driver and co-driver from rocket blast and propellant powder particles. It covers the top of the cab from the windshield to the cross box and from that point slopes downward to the top of the bulkhead which forms the forward end of the cargo space.

#### **106. FIRING MECHANISM.**

a. **General.** The electric firing system for this launcher depends upon the storage battery of the vehicle for a source of current. A portable firing control box for controlling the firing circuits to the individual launcher tubes is situated in cab of the *DUKW* for operation by the co-driver (fig. 49). The firing system is connected to the electric system by a feed wire between the control box and a power

**GROUPS COMPRISING LAUNCHER T44 WHEN MOUNTED IN  
2½-TON 6 x 6 AMPHIBIAN TRUCK, GMC, DUKW-353**

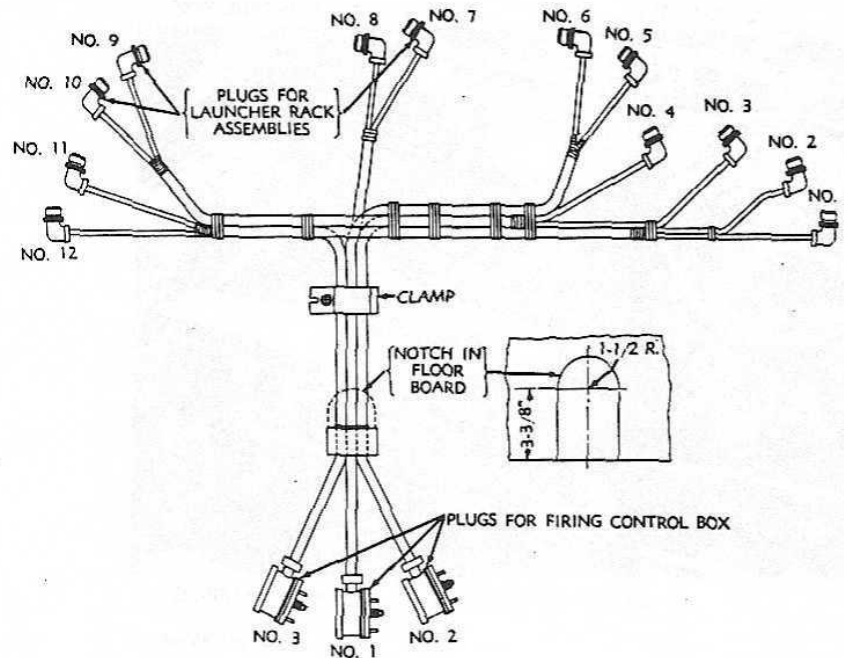

RA PD 50570

**Figure 48—Wiring Harness**

connector on the dashboard. Current to the individual rockets passes through the wiring harness which is connected to the control box and launcher tubes.

**b. Firing Control Box (fig. 13).**

(1) The firing control connections are arranged so that the rockets in an individual rack are fired, beginning with the rear tube and proceeding forward in sequence, before firing is started from another rack.

(2) The firing control box incorporates a motor-driven selector switch having 120 contact points which are connected through the wiring harness and its plugs to the 12 tube racks and finally to the individual tube firing contacts. The motor gearing is arranged so that the selector switch contact points are closed in sequence at intervals of one half second. Thus a complete salvo of 120 rockets can be fired in 60 seconds if desired.

(3) The firing control box also incorporates two safety plugs, a master power switch, an indicating lamp, two firing control push but-



4.5-INCH ROCKET MATERIEL FOR GROUND USE

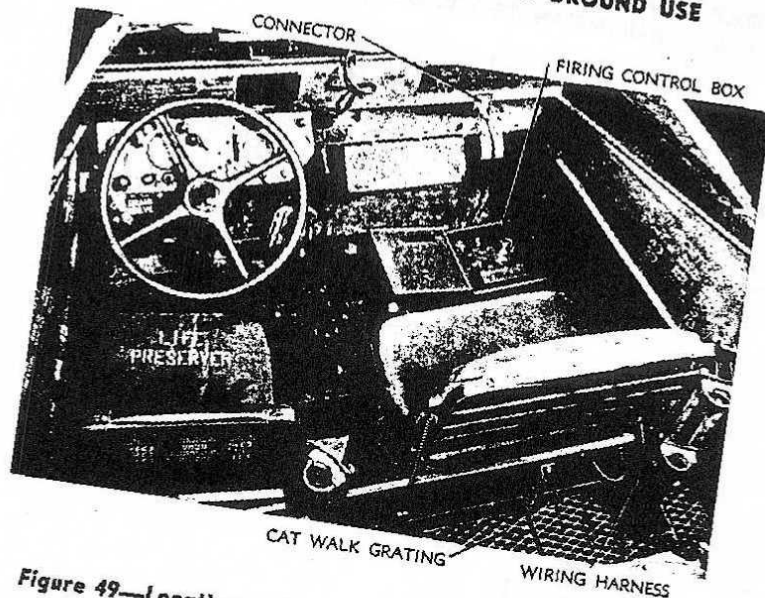

Figure 49—Location of Firing Control Box in Cab of DUKW

RA PD 19745

tons, a selector switch indicator which consists of two dials, and a means of operating the selector switch manually, in case of failure of the motor drive.

(4) Three plug contacts are provided on one side of the firing control box so that the box can easily be disconnected from the wiring harness. Both the plugs and the sockets are numbered for easy identification. *These connections should be made only while the safety plugs are removed from the box and just prior to firing rockets.*

(5) Two drain plugs are provided in the forward face of the box, one for the upper section and one for the lower section. If the vehicle has operated through surf or box has otherwise been exposed to water, these plugs should be removed and the box tipped up on a corner to drain out any water which might have entered.

(6) The two safety plugs are identical in design but can perform different functions. Two receptacles for storing these plugs, when not in use, are located in the top part of the panel. One plug provides a positive means of breaking the firing circuit in the control box and keeping it open while the launcher is being loaded with ammunition or during any other time when it may not be safe to fire. The other plug is used as a knob for manual operation of the selector



**GROUPS COMPRISING LAUNCHER T44 WHEN MOUNTED IN  
THE LANDING VEHICLE, TRACKED (A) (4)**

switch. *The safety plugs must always be removed from the firing control box before loading the launcher and should be carried by the loader or a responsible fire control officer until all personnel are in the clear and it is safe to fire. During periods of inactivity, the plugs should be left in their receptacles.*

(7) *The master power switch also provides a means of breaking the firing circuit and keeping it open. This switch is effective only after the safety plug has been inserted in its socket. When turned on, the switch lights the indicating lamp, thereby showing that the control box is set to fire the launcher.*

(8) *A "hold" and a "fire" push button are located in the firing control box.*

(9) *The circular window houses two white arrows, each on its own disk. During normal operation these arrows rotate together so as to point to each other. If they were not in line, indication is given that the selector switch has been operated manually or otherwise disturbed, since firing stopped.*

(10) *The rectangular window shows the position of the selector switch and therefore the number of rockets fired. The switch and its indicator may be set to "0" or any other number corresponding to the launcher tube from which firing is to be started.*

(11) *Hand operation of the selector switch is available in case the motor connected to the selector switch does not operate.*

---

**Section XXV****GROUPS COMPRISING LAUNCHER T44 WHEN  
MOUNTED IN THE LANDING VEHICLE,  
TRACKED (A) (4)****107. GENERAL.**

a. *The Launcher T44 is issued mounted in the LVT (A) (4); however, due to the differences in the size and construction of its cargo space, the following components replace or augment similar components used when mounted in the DUKW:*

(1) **REAR CROSS BEAM.** *A different rear cross beam is used. This cross beam is supported by two "A" frame supports and is fastened to the walk of the cargo space by two turnbuckles. The front cross beam is the same as that used in the DUKW.*

(2) **"A" FRAME SUPPORTS.** *Two "A" frame supports are issued for supporting the rear cross beam. Each support stands near a rear corner of the cargo space against the side wall.*

**TM 9-394**

**107-108**

#### **4.5-INCH ROCKET MATERIEL FOR GROUND USE**

(3) **"L" SUPPORTS.** Two "L" supports are issued for supporting the front cross beam. The short arm of each support rests near the forward corner of the "cat-walk" deck and the long arm hangs downward inside the cargo space. Each is held in position by two tie rod assemblies attached to cargo securing rings.

(4) **CABLE SUPPORT.** The cable support is located in the front bulkhead of the right companionway. This companionway is the space to the right of the engine. The support acts as a holder and insulator for the wiring harness cables running from the launcher in the cargo space to the firing control box in the cab.

(5) **SPREADER.** The spreader is a V-shaped sheet-metal support which rests on the floor of the cargo space between the "A" frame supports. It supports the lower side of the flame deflectors.

(6) **TIE ROD ASSEMBLIES.** Three pairs of tie rod assemblies are used. Each assembly consists of a turnbuckle and two iron rods ending in a hook. The shortest tie rod assemblies are used for fastening each "L" support to a ring at the front of the cargo space. The longest tie rod assemblies are used for fastening each "L" support to a ring at the center of the cargo space. The medium length tie rod assemblies are used for fastening the rear cross beam to rings near the rear of the cargo space.

(7) **REGISTER ASSEMBLY.** The register assembly reduces the 12-volt power source of the LVT to 6 volts, the operating voltage of the firing control box.

---

### **Section XXVI**

#### **GROUPS COMPRISING LAUNCHER T45**

##### **108. LAUNCHER BODY ASSEMBLY (fig. 35).**

a. **General.** The launcher body assembly is a welded steel framework 12 $\frac{1}{8}$  inches wide, containing one launching rail 62 inches long and two vertical framework magazines, side by side. The right-hand magazine is known as the firing magazine and is directly above the launching rail. The left-hand magazine is known as a supply magazine, which extends about three quarters of the way down the launcher, and ends in a table inclined towards the firing magazine.

##### **b. Adjustment.**

(1) There should be a clearance of  $\frac{1}{8}$  inch between all guides and adjacent surfaces of the rocket. Pass a rocket through the magazines to check for proper clearance. Roll rockets down inclined table

**GROUPS COMPRISING LAUNCHER T45**

into firing magazine to check for proper clearance. Any interference should be corrected by bending parts of launcher.

(2) There should be a clearance of  $\frac{1}{8}$  inch  $\pm$   $\frac{1}{32}$  between rocket body and right front guide when a rocket is held against two reel rods and moved up and down in firing magazine. Check in all three sectors of reel. If clearance is exceeded there is danger of reel rod engaging a rocket in such a way as to cause a jam. Any necessary correction to maintain the  $\frac{1}{8}$ -inch  $\pm$   $\frac{1}{32}$ -inch clearance should be made by bending the front guide.

(3) There should be a clearance of  $\frac{3}{16}$  inch between reel rods and bottom of inclined table and between reel rods and the top of the left way of the launching rail. Make sure that the flats at rear end of each reel rod will clear the front shroud of rocket. This is important because otherwise a short circuit will occur and rockets will not fire. Make necessary corrections to obtain clearance by bending parts of launcher.

**109. GATE ASSEMBLY (fig. 50).**

a. **General.** The gate assembly consists of two loosely jointed rectangular frames suspended between the supply and firing magazines. The lowest longitudinal bar of the lower member of the gate assembly contains two latches which can rest against the inclined table. During that cycle of the launcher operation when the firing magazine contains rockets, the latches rest against the left edge of the table. After rockets in the firing magazine have been fired, the rockets in the supply magazine push the gate assembly to the right and the latches clear the table, thereby allowing the rockets to roll over the table to the reel and into the launching rail.

**110. REEL ASSEMBLY (fig. 50).**

a. **General.** The reel, located in the lower center part of the launcher, allows one rocket at a time to drop into the launching rail in the correct position for firing. During firing, the reel rests on the rocket in the launching rail and is free to turn and drop the next rocket into position only after the previous rocket has been fired.

**111. CONTACT BOX (fig. 51).**

a. **General.** The contact box is the mechanism which provides contact between the rocket shrouds and electric system. Two hardened, spring-loaded knife-edge contacts act as contact points and protrude through the contact box in such positions that the forward knife edge is struck by the forward shroud and the rear knife edge is struck by the rear shroud when a rocket drops into the launching

4.5-INCH ROCKET MATERIEL FOR GROUND USE

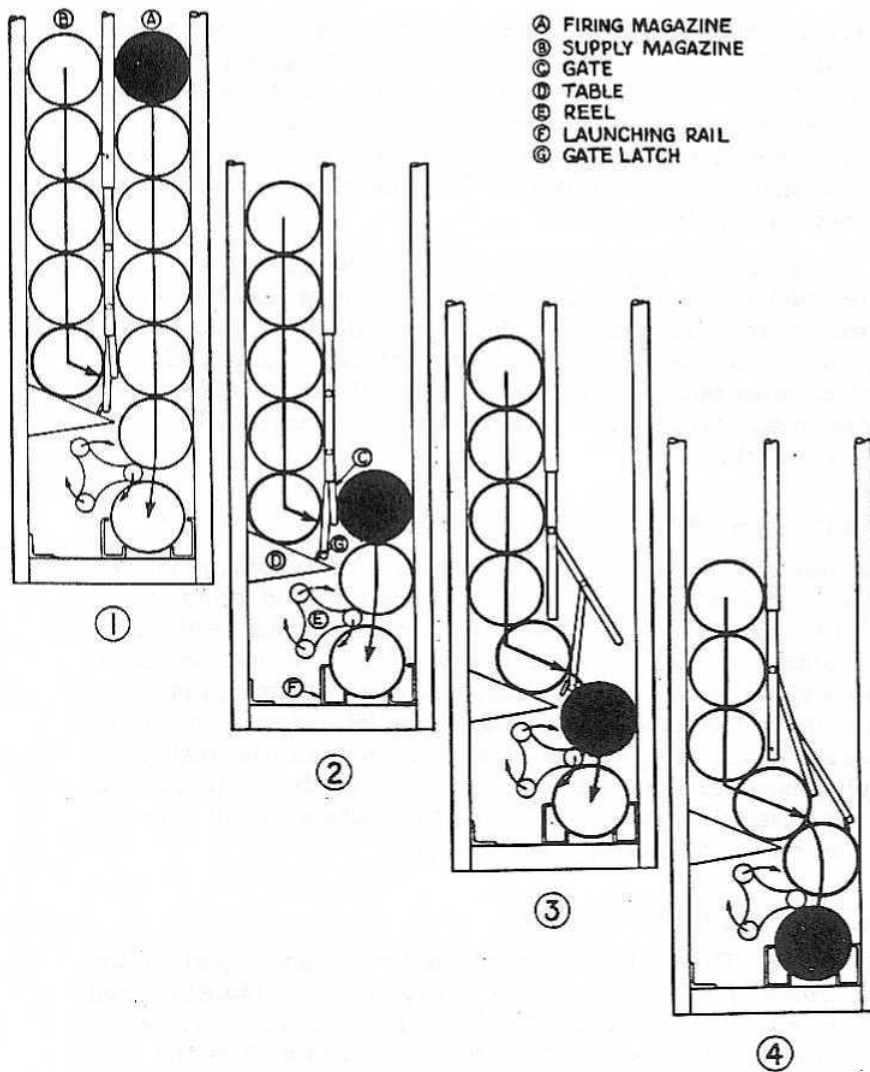

RA PD 50587

Figure 50—Functioning of Launcher

GROUPS COMPRISING LAUNCHER T45

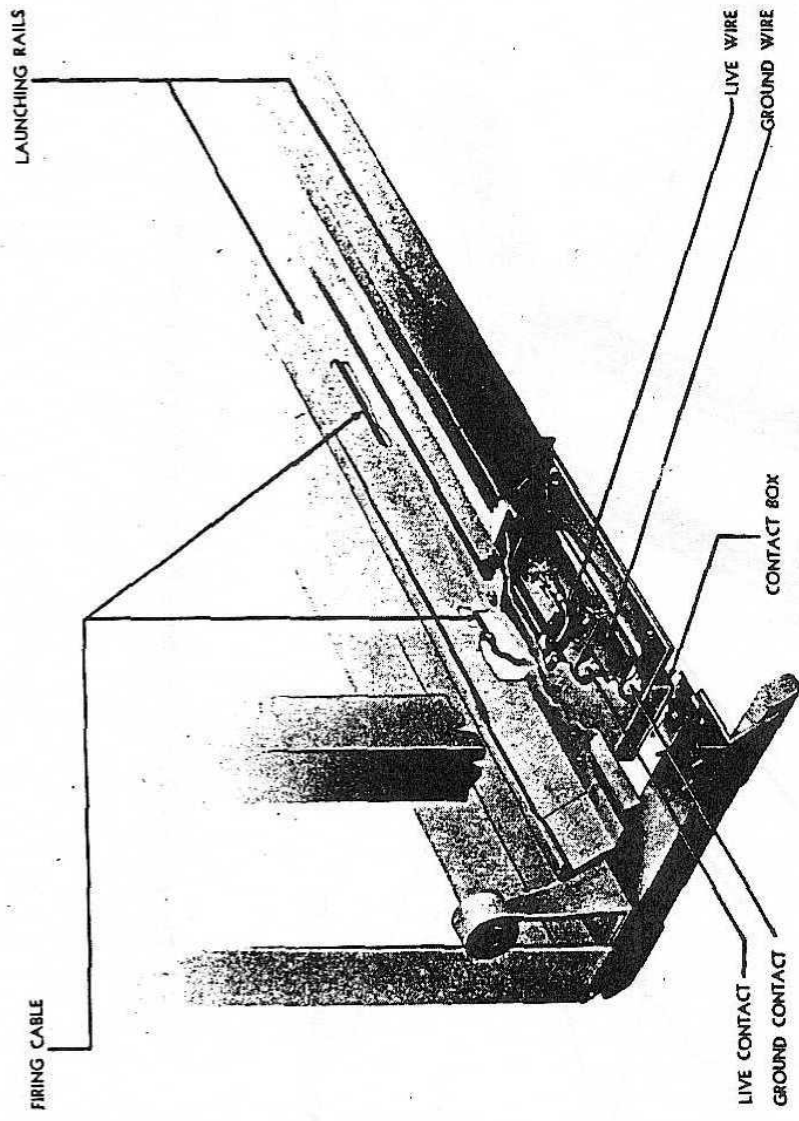

RA PD 50585

Figure 51—Contact Box Showing Wiring Connection

4.5-INCH ROCKET MATERIEL FOR GROUND USE

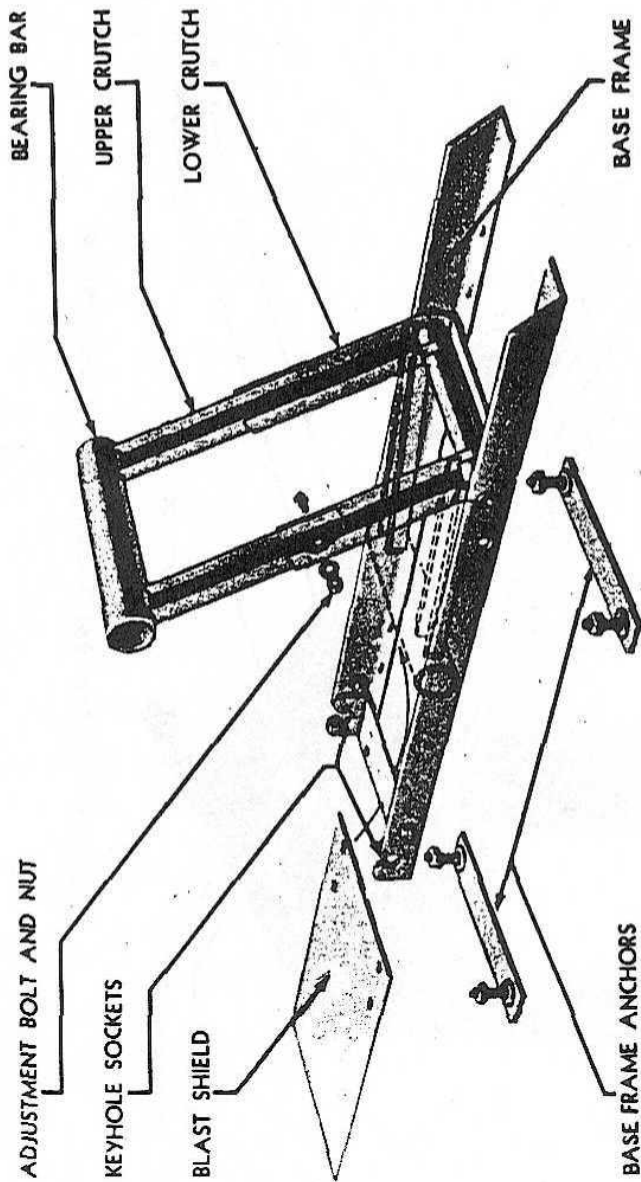

RA PD 50586

Figure 52--Details of Base Frame and Crutch Assembly

**GROUPS COMPRISING LAUNCHER T45**

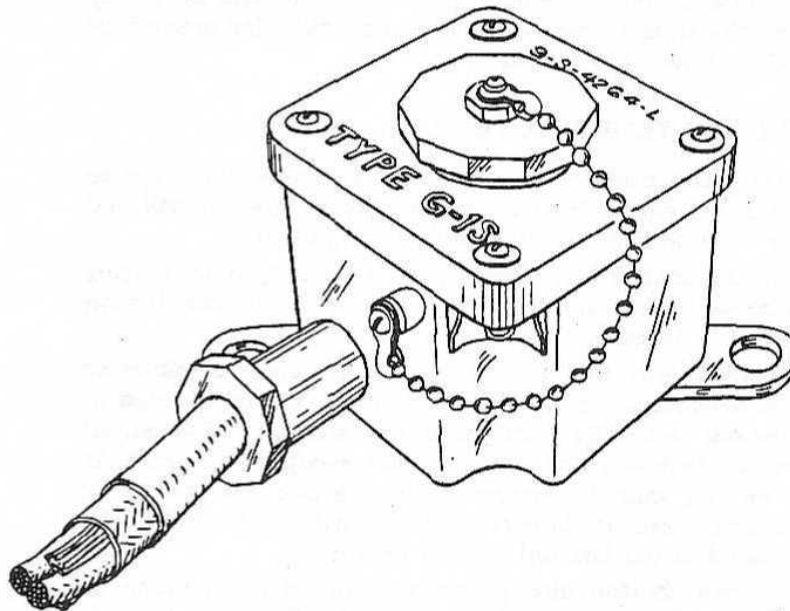

RA PD 50577

**Figure 53—Junction Box**

rail. The forward contact carries the electric current to the rocket and rear contact acts as the ground. One terminal of firing cable is connected to one contact and the other terminal to the other contact.

**112. FIRING CABLE.**

a. **General.** The firing cable which is fastened to the contact box of the launcher is 10 feet long. This cable contains two conductors, each of which is connected to a separate contact point in the contact box. Two cord brackets, located to the left of the launching rail, are provided for storage of the cable when not used. A polarized receptacle plug, issued for assembly to the end of this cable, connects the cable to a junction box. Some launchers may be issued with this receptacle plug already fastened to the cable.

**113. CRUTCH ASSEMBLY AND BASE FRAME (fig. 52).**

a. **General.** The crutch assembly and base frame serve as an adjustable bracket. The crutch is a simple elevating device which provides adjustment in elevation between 27 degrees and 50 degrees in approximately 5-degree steps. Being rigid, the launcher assembly is tilted on its rear lower corner by the crutch which is clamped to the launcher front support assembly. The base frame and clutch may



#### 4.5-INCH ROCKET MATERIEL FOR GROUND USE

be permanently installed on a vehicle and the launcher can be readily removed from the base frame and crutch assembly for storage or emplacement on other base frames.

#### 114. FIRING CONTROL BOX (fig. 16).

a. **General.** The firing control box and its connections are so arranged that either one or both launchers may be fired at will and each launcher may be fired in single action or ripple fire.

(1) The firing control box panel contains a safety plug, a firing pilot light, a power button, and two firing buttons. Each firing button controls a different launcher.

(2) The safety plug provides the means of safely breaking or completing the electric firing circuits. *This plug must be inserted in the socket marked "SAFETY" only after the launcher is loaded, all personnel are in the clear, and the launchers ready to be fired.* At other times the plug must be removed from the box and carried by the loader or other responsible personnel who will see to it that the plug is not placed in the box until ready for firing.

(3) The power button also provides a means of breaking or completing electric firing circuits. This button is effective only after the safety plug has been inserted in its socket. When depressed, the power button lights the firing pilot light, thereby showing that current is available and the control box set to fire the launchers.

(4) The firing buttons for No. 1 or No. 2 launchers must be operated only while the safety plug is in position and the power button depressed.

(5) Three tubular openings are located in the front of the firing control box. The left opening receives the lines from the battery or other source of electricity, the upper center opening receives the line from the junction box for launcher No. 1 and the right opening receives the line from the junction box for launcher No. 2.

(6) A receptacle cap is chained to the left side of the firing control box and screws on a blank socket when not in use. This cap should normally be screwed over the safety plug socket when the safety plug is not inserted in it.

(7) A drain plug is provided for draining water which might enter the box.

#### 115. JUNCTION BOX.

a. **General.** The junction box (fig. 53) is an electric socket which provides a means for readily connecting the launcher to the electric system. When not in use, the opening should be covered by the cap chained to the box.

## PART FOUR—AUXILIARY EQUIPMENT

### Section XXVII

#### GENERAL

#### 116. SCOPE.

a. Part four contains information for the guidance of the personnel responsible for the operation of this equipment. It contains only the information necessary to using personnel to properly identify, connect, and protect such auxiliary equipment while being used or transported with the main equipment. Detailed instructions pertaining to auxiliary equipment are contained in pertinent TM's.

---

### Section XXVIII

#### AMMUNITION

#### 117. GENERAL.

a. A rocket is a projectile which carries its propelling charge within itself. The propelling charge burns and produces a large volume of gas which is ejected at high velocity from the tail of the rocket. The reaction to this jet of gas drives the rocket forward. The principle is the same as that which causes a rifle to kick when a blank cartridge is fired.

#### 118. CLASSIFICATION.

a. **Stabilization.** Rockets are classified according to the means employed to stabilize their flight as fin-stabilized and spin-stabilized. Fin-stabilized rockets are equipped with fins which act as rudders to keep the rocket on its course. Spin-stabilized rockets use rotation of the rocket on its axis in the same manner as do rifle-fired projectiles.

b. **Filler.** Rockets are classified according to the shell filler as high explosive, chemical, and practice. High explosive rockets contain an explosive charge for blast, fragmentation, or mining effect similar to that of an artillery shell. Chemical rockets contain chemical filler and a small explosive charge for opening the shell and distributing the chemical agent. Practice rockets usually contain no bursting charge but may, in certain cases, contain a spotting charge.

4.5-INCH ROCKET MATERIEL FOR GROUND USE

119. IDENTIFICATION.

a. Ammunition is identified from the painting and marking on the item itself and on all inner and outer containers. Complete identification consists of the standard nomenclature and the ammunition lot number.

b. **Painting.** Ammunition is painted to prevent rust and to provide, by the color, ready identification as to type. In accordance with the basic color scheme, rocket motors are painted olive drab and marked in yellow. Rocket shells are painted the same as the corresponding types of artillery shells.

c. **Marking.** Marking is stenciled on the item or stamped in the metal. Stenciled information includes type, size, and model of the item, the ammunition lot number, loader's symbol, and date loaded. Other pertinent information, such as temperature limits, may also be stenciled on the item. Component lot numbers are stamped in the metal.

d. **Ammunition Lot Number.** When ammunition components are manufactured a lot number is assigned in accordance with pertinent specifications. The items in each lot are manufactured under uniform conditions and may be expected to function in a uniform manner. For greatest accuracy in firing, successive rounds should be of the same lot. In general, the lot number consists of the number of the lot, the loader's initials, and the date loaded.

e. **Standard Nomenclature.** Standard nomenclature includes the name of the item, the type, the size, and the model number. Standard nomenclature of rockets and rocket components is listed in ORD 11 SNL S-9. Standard nomenclature is required for all purposes of record except where the Ammunition Identification Code (AIC) symbol is used. This is a combination of five characters, the first two representing the SNL in which the ammunition is reported, the last three identifying the item as packed. The AIC symbol is used to facilitate requisitioning, reporting and records in the field.

f. **Model Number.** When an item of ammunition is adopted as standard, a model number, consisting of the letter M and an arabic numeral, is assigned. If the item is modified, the letter A and an arabic numeral are added. When an item is not yet standardized or is under service test, the model designation consists of the letter T and a numeral, with modifications designated by the letter E. When such an item is standardized, items already marked with the T number are not usually restenciled, hence they may be issued bearing the original marking.

## AMMUNITION

### 120. COMPONENTS.

a. **Complete Round.** The complete round of rocket ammunition consists of a shell with fuze and booster and motor with an igniter. The 4.5-inch rocket is issued as unfuzed complete rounds.

b. The various components are described under the particular type of rocket below.

### 121. FIN-STABILIZED ROCKETS—ARMY-TYPE.

a. **Data.** The Army 4.5-inch fin-stabilized rocket (fig. 54) is approximately 33 inches in length and weighs 40 pounds as fired. Maximum velocity is 850 feet per second at 70 feet from the launcher. Maximum range is 4,600 yards but a large inherent dispersion limits effective aimed fire to shorter ranges. The effect of the high-explosive rocket is similar to that of a 105-mm HE Shell M1. The fuze authorized for ground use is the PD Rocket Fuze M4A1, SQ-0.1-second delay, with Auxiliary Booster M1, and modifications of this model.

b. **Shell.** The rocket shell (fig. 55) is loaded with high explosive for service rounds, or inert material for practice rounds. It is approximately 1.6 calibers in length, and has an ogive of 2 calibers radius. It contains a fuze well cup and burster tube. In storage and transit, the fuze well cup is closed by a shell plug screwed into the nose of the shell, and held by a set screw. The burster tube projects about 15 inches into the center of the rocket motor body which it uses as an additional source of fragments.

c. **Motor.** The motor body is a steel tube constricted near the tail end to form a nozzle. It contains the propelling charge and igniter. The forward end is threaded for assembly to the rocket shell, and the fin assembly is fastened to the rear end of the nozzle. The fin assembly consists of a fin ring holding six folding fins in a circle. The fins, when folded, fit around the nozzle of the rocket motor and are held in place by a fin retainer ring. When the rocket leaves the launcher, the fins are opened to a 12-inch spread by acceleration. A safety groove is formed in the motor body to permit it to separate at a definite point, should an excessive pressure be generated within the motor body on firing. Such occurrences are very rare, but can be expected if the rocket is fired when its temperature is above that given as its safe operating temperature, or if the nozzle should become blocked. When separations occur, the shell and the propellant charge will travel forward with low velocity and have a range of from 100 to 1,000 yards. The motor body will be blown backward from the launcher tube for some distance.

TM 9-394  
121

4.5-INCH ROCKET MATERIEL FOR GROUND USE

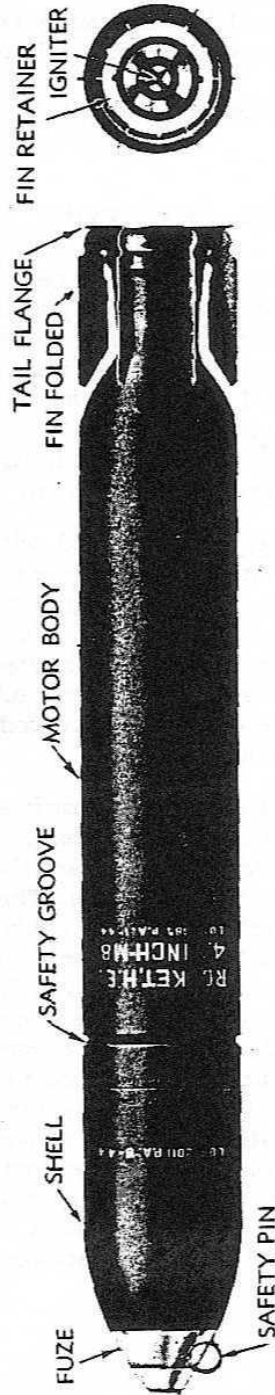

DA PD 26757

Figure 54—Rocket M8

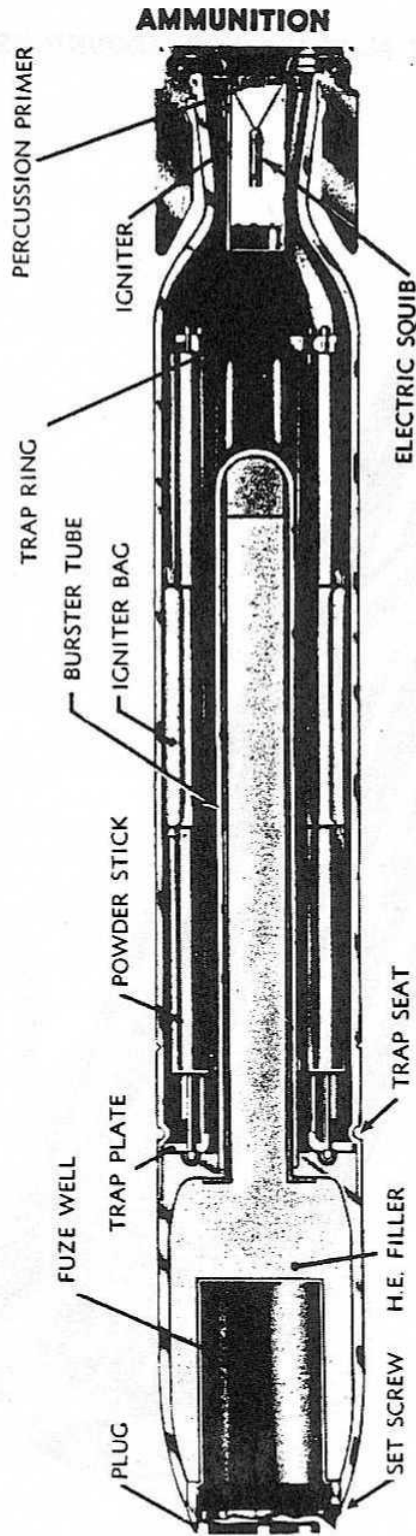

105

RA PD 26759A

Figure 55—Rocket M8—Sectioned

TM 9-394

121

4.5-INCH ROCKET MATERIEL FOR GROUND USE

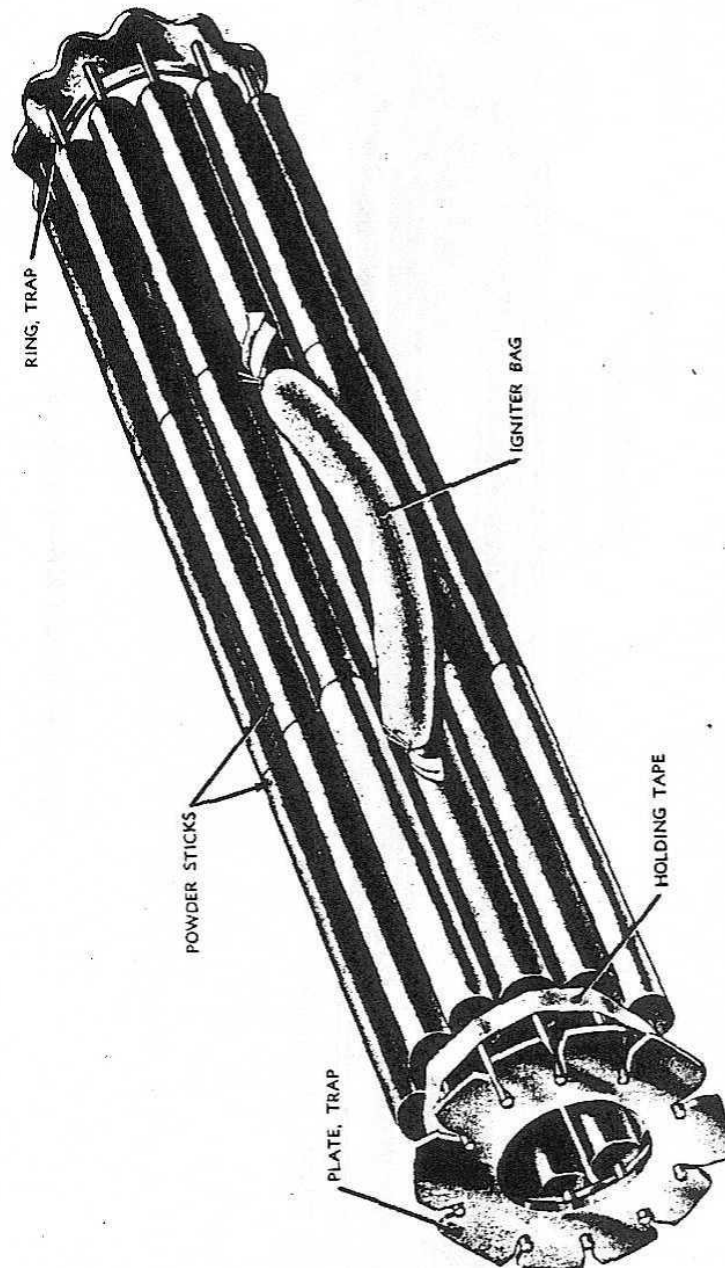

RA PD 26759

Figure 56—4.5-inch HE Rocket M8—Trap Assembly



AMMUNITION



RA PD 26760

Figure 57—Igniters

d. **Propelling Charge.** The propelling charge (fig. 56) consists of 30 sticks of rocket powder strung on the wires of the trap. The trap consists of 10 wires attached to a trap ring and an annular trap plate which has holes to receive the top ends of the wires. The trap plate rests on the trap seat formed in the forward end of the rocket motor body. Each rocket is loaded with a specific weight of powder. The safe temperature limits for the rounds are marked on the rocket body.

e. **Igniter.** The igniter (fig. 55) consists of a charge of black powder and an electric squib. The squib and black powder are inclosed in a waterproof paper cup fitted into the nozzle opening where it is secured with cement. The leads of the squib are connected to a contact disk and a contact ring on the base of the cup (fig. 57). In combination igniters, a percussion primer is assembled in the center contact plate in the base.

122. MODIFICATIONS.

a. The various models and modifications of 4.5-inch fin-type rockets are described below (figs. 58, 59, and 60).

(1) 4.5-INCH HE ROCKET M8 AND 4.5-INCH PRACTICE ROCKET M9.

(a) The original model of the 4.5-inch rocket has a comparatively light shell and motor body. As a consequence, safe temperature ranges are narrow, and it is necessary to change the propelling charge to provide for full coverage of the temperature range. As issued, the charge is adjusted for firing at temperatures between +20°F and +90°F. The charge may be modified as described below for firing at temperatures between +50°F and +130°F. The temperature at the time of firing governs the selection of the charge. Under no circumstances should a rocket be fired at a temperature outside the range for which the charge is adjusted.

4.5-INCH ROCKET MATERIEL FOR GROUND USE



RA PD 26761

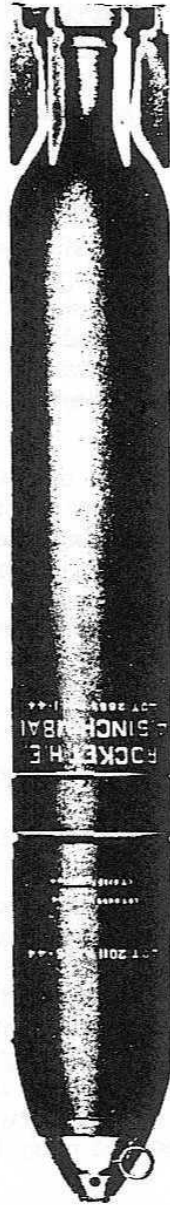

Figure 58—Rocket M8A1



RA PD 26762



Figure 59—Rocket T22

AMMUNITION

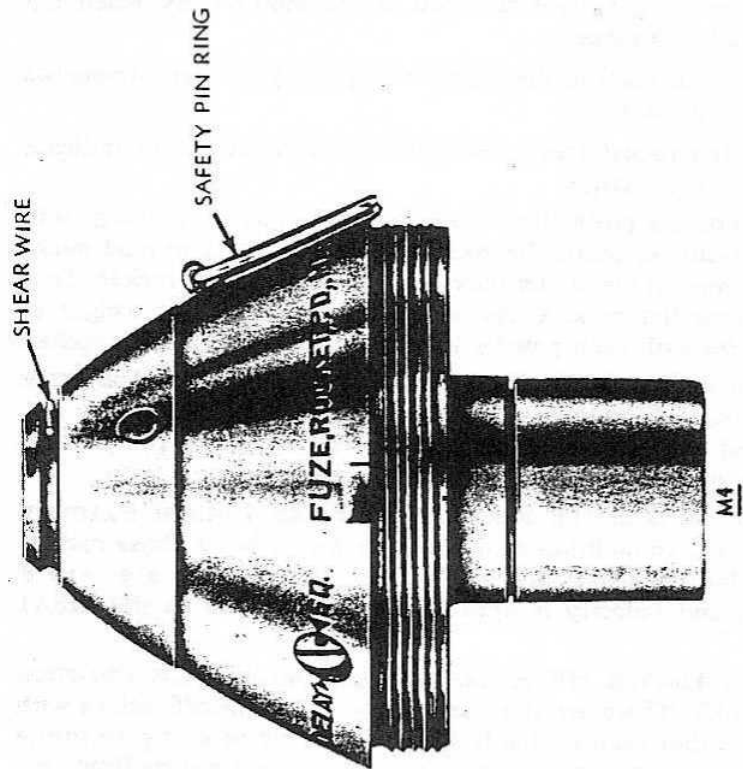
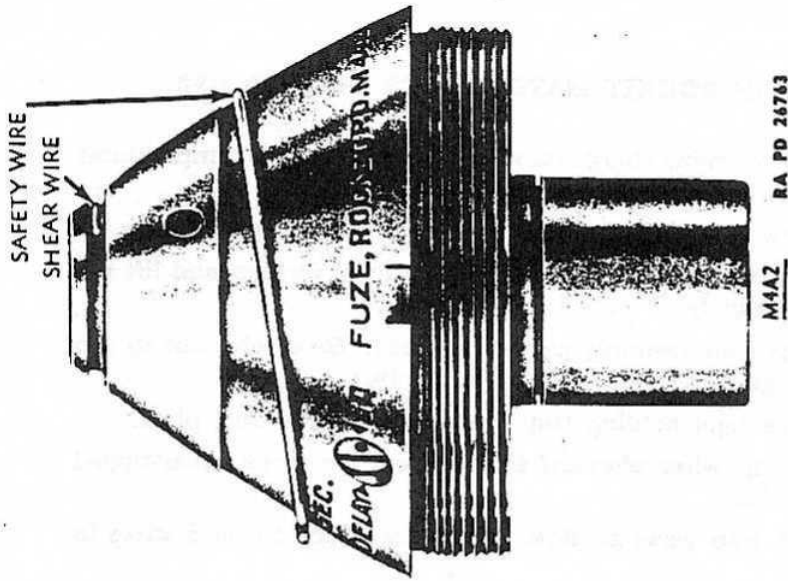

Figure 60—PD Rocket Fuzes M4 and M4A2

**4.5-INCH ROCKET MATERIEL FOR GROUND USE**

(b) The propelling charge may be adjusted for high temperatures as follows:

1. Unscrew the shell from the body, using two strap wrenches.
2. Place the rocket, nose up, on a clean level surface, and lift the shell out of the body.
3. Lift the trap assembly out of the body. Be careful not to rub the igniter bags against the wall of the body.
4. Remove tape holding trap wires in place in trap plate.
5. Push trap wires outward and remove the three silver-tipped sticks of powder.
6. Return trap wires to slots and replace tape to hold wires in place.
7. Lower trap assembly into the motor body. Make sure the igniter bags are on the outside of the powder sticks, and that they are not damaged by rubbing against the wall of the motor body when the trap is lowered into place.
8. Replace the shell in the rocket body, using the strap wrenches to insure a tight joint.
9. Mark the rocket body, and packings if repacked, to indicate the change in the charge.
10. If there is a probability that the low-temperature charge will need to be restored, mark the rocket body and the removed sticks so that the same three sticks may be returned to that rocket. It is mandatory that the same sticks be replaced because the weight of the stick varies with each powder lot and is adjusted for each rocket.

(2) THE 4.5-INCH HE ROCKET M8A1 AND 4.5-INCH PRACTICE ROCKET M9A1. These rockets have a strengthened motor body and may be fired at temperatures between  $-10^{\circ}\text{F}$  and  $+105^{\circ}\text{F}$ . No modification of the propelling charge is necessary.

(3) THE 4.5-INCH HE ROCKET M8A2 AND 4.5-INCH PRACTICE ROCKET M9A2. In addition to the heavier motor body, these rockets have a smaller, heavier-walled shell. Temperature limits are  $-10^{\circ}\text{F}$  to  $+105^{\circ}\text{F}$ , and velocity is approximately the same as the M8A1 round.

(4) THE 4.5-INCH HE ROCKET M8A3 AND 4.5-INCH PRACTICE ROCKET M9A3. These are the same as the M8A2 modifications with the exception that each fin blade has a slight bur or crimp to insure a tight fit in the fin ring when the fin opens. Its temperature limits are  $-10^{\circ}\text{F}$  to  $+105^{\circ}\text{F}$ .

(5) THE 4.5-INCH HE ROCKET T22 AND 4.5-INCH PRACTICE ROCKET T46. These retain the heavier shell of the M8A2 Rockets.

AMMUNITION

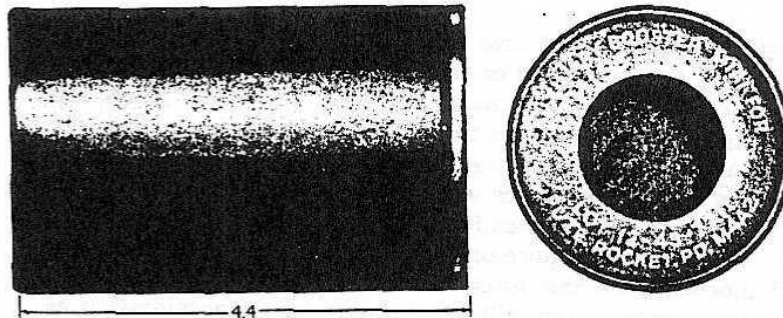

RA PD 65193

Figure 61—Auxiliary Booster M1 AND M1A1

The motor body is further strengthened and the fin assembly is modified. The igniter is assembled in a plastic tube attached to the trap and extending the length of the propelling charge. Its temperature limits are  $-20^{\circ}\text{F}$  to  $+120^{\circ}\text{F}$ .

123. FUZES FOR FIN-STABILIZED ROCKETS.

a. **Description.** PD Rocket Fuze M4 (fig. 60) is a point-detonating, selective superquick-delay type. The time of delay is indicated in the nomenclature and is marked on the fuze. The delay is 0.1 second for ground use and 0.015 second for aircraft use. The Auxiliary Booster M1 (fig. 61) is an essential part of the fuze and is packed in the same can. The fuze is detonator safe, that is, the detonator is held out of line until after the rocket is fired. Accidental arming of the fuze is prevented by a cotter pin and safety pin ring in earlier models, and by a safety wire in later modifications. The safety pin or wire must be removed just before loading the rocket into the launcher and at no other time. The striker of the fuze is held in place by a shear wire which passes through the striker and the fuze body, and appears in the groove just behind the point of the fuze. The shear wire must not be disturbed. If it is missing, the fuze should be handled, point down, with extreme care, until it can be destroyed.

b. **Fuze Setting.** The action of the fuze is selected by means of a setting pin which appears at the side of the fuze. The head of the pin is slotted and is marked with an indicator dot. The fuze body is marked on either side of the setting pin with "SQ" and "0.1 SEC. DELAY" (or "0.015 SEC. DELAY"). The action of the fuze is selected by turning the pin so that the dot indicates the desired action. Note that the pin slot should always be parallel to the axis of the fuze. The fuze may be reset at any time prior to firing.

**4.5-INCH ROCKET MATERIEL FOR GROUND USE**

c. **Arming.** This type of fuze arms in three steps: the first step is the removal of the safety pin or wire; the second, the forces of set-back initiate arming when the rocket is fired; the third, when set-back ceases, spring action unlocks the detonator slider and moves the detonator into line in the explosive train. Note that the fuze cannot function unless the safety pin or wire is removed before firing. The Fuze M4 will arm on the set-back force resulting from 165 G acceleration. Later modifications require only 100 G. Compared with artillery and trench-mortar fuzes, this force is extremely small. The set-back force in artillery ammunition will be produced by an acceleration as great as 20,000 G and in trench-mortar ammunition by an acceleration as great as 4,000 G. Consequently, once the safety pin has been removed, rockets should be handled with extreme care.

d. **Fuze M4A1.** This fuze differs from the M4 in that a lighter set-back is required to arm the fuze. The setting pin is recessed, and a piece of scotch tape covers the nose. The setting pin is recessed in order to prevent its partial turning upon impact, as a partial turn would result in a dud. The tape should not be removed prior to firing, as it is required to prevent quenching of the delay element upon water impact.

e. **Fuze M4A2.** In this modification, the design of the setting pin is slightly changed so that the delay train will always function. In the earlier modifications, if the setting pin slot is not parallel with the axis of the fuze, the fuze will be a dud. This model is supplied with the Auxiliary Booster M1A1.

f. **Auxiliary Booster.** This component is required to insure high-order detonation of the bursting charge. It consists primarily of a chip-board and metal container filled with approximately one pound of TNT. The M1 is in the form of a cylinder with flat ends. The M1A1 contains a cup in the top to nest over the booster cup of the fuze.

g. **Dummy Rocket Fuze M6.** The dummy fuze has the same weight and contour as the service fuze. It is issued for use with the practice rocket.

**124. PREPARATION FOR FIRING.**

a. To prepare the rocket for firing, the following steps should be taken:

(1) Remove the rocket from its packing and inspect for serviceability. Be sure that the igniter and fin retainer are firmly in place, that fins are straight, and the rocket motor body is not seriously dented. Make certain that the temperature range specified for the charge covers the expected temperature at firing. If necessary, adjust the propelling charge of Rockets M8 and M9 as described in paragraph 122 a.



## AMMUNITION

- (2) Fuze the rocket as follows:
  - (a) Unpack the fuze and inspect it for corrosion and other evidence of serviceability. Be sure the safety pin and shear wire are in place.
  - (b) Set the fuze for the desired action (par. 123 b).
  - (c) Loosen the set screw in the nose of the rocket and remove the shell plug. Examine the fuze well cup to be sure that it is free of foreign material.
  - (d) Insert Auxiliary Booster M1 into the fuze well cup with the end marked "THIS END UP" toward the nose of the rocket.
  - (e) Screw the fuze into the rocket and tighten with fuze wrench.
  - (f) Tighten set screw.
- (3) Remove the safety pin or wire from the fuze.
- (4) Load the rocket into the launcher in accordance with directions pertinent to the particular launcher.
- (5) If the rocket is not used, unfuze by reversing the above step, and return to storage.

### 125. FIN-STABILIZED ROCKETS—NAVY-TYPE.

a. **General.** The 4.5-inch Navy rocket, commonly called the Beach Barrage rocket (BR), is a fin-stabilized projectile consisting of a fuzed body (note variation in nomenclature) and a motor with igniter and shrouded fins (figs. 62 and 63). The body may be loaded with high explosive or phosphorus. Body, motor, and fuze are issued separately.

b. **Body.** The rocket body (shell) is cylindrical with a hemispherical nose and tapered rear. The nose contains a fuze well and the tapered end is closed with an adapter for attachment of the motor.

c. **Motor.** The motor is a steel tube 2.25 inches in diameter and 15 inches in length. It contains an electric igniter, a propellant grain, and a bag of drying agent. Both ends of the motor are sealed by waterproofed fiber disks. The front end of the motor tube is threaded for assembly to the adapter in the body, the rear end carries two fin shrouds which serve as flight stabilizers and as electrical contacts with the launcher. As issued, a shorting clip protects the igniter from accidental ignition. This clip must be removed when the rocket is loaded into the launcher.

d. **Fuze.** The Fuze Mk. 137 (fig. 64) is authorized for use with the HE round. The Fuze Mk. 154, a modification of this type which has a burster assembled, is authorized for the smoke rocket. This type fuze arms with 8 to 10 turns of the propeller (100 to 125 feet, air travel) after setback on firing releases the propeller lock. The



**4.5-INCH ROCKET MATERIEL FOR GROUND USE**

detonator is held out of line by the firing pin while the fuze is un-armed. On rotation of the propeller, the firing pin is withdrawn and the detonator shutter rotates to align the detonator with the firing pin and the booster lead cup. *Any attempt to turn the propeller back after the fuze has armed will fire the fuze.*

**e. Inspection Prior to Use.**

(1) **MOTOR.** Be sure the safety shorting clip is in position. See that closing disks are in place at both ends of the motor, that threads and fins are not damaged, and that lead wires are not broken or insulation damaged.

(2) **BODY.** Be sure that fuze cavity is clear of foreign material and that fuze and adapter threads are clear and undamaged.

(3) **FUZE.** Be sure that the fuze safety wire is in place. Remove the safety wire and try the propeller to be sure that the lock pin prevents its turning. Depress the lock pin with the safety wire to insure that the setback block is free to move and will snap back into place. Replace the safety wire.

**CAUTION:** *If at any time the fuze propeller is found to project beyond the rim of the propeller guard, the fuze will be considered armed and disposed of as dangerous.*

**f. Assembly of Complete Round.**

(1) Inspect components as described above.

(2) Remove shipping plugs from fuze well and motor adapter.

(3) Screw motor into adapter, use a strap wrench to tighten. Be sure that one inch or more of motor threads are engaged.

(4) Screw fuze into fuze seat and tighten with wrench supplied in fuze box.

(5) Remove fuze safety wire when rocket is loaded into launcher.

**g. Disassembly.** If rocket is not used, disassemble and return components to original condition and packing by reversing the above steps.

**126. SPIN-STABILIZED ROCKETS.**

**a. Data.** The spin-stabilized rocket (fig. 65) is approximately 31 inches long and weighs 42.5 pounds. Maximum velocity is 830 feet per second at 70 feet from the launcher. Maximum range is 5,300 yards, dispersion is approximately 8 mils.

**b. Shell.** The rocket shell is essentially the same as that for the fin-type rockets described above (par. 121) except that the fuze well and adapter differ slightly (compare figs. 55 and 66). The high explosive shell (T38E3, T38E7) is loaded with 5.3 pounds of TNT. The practice shell (T39E3, T39E7) is filled with inert material.

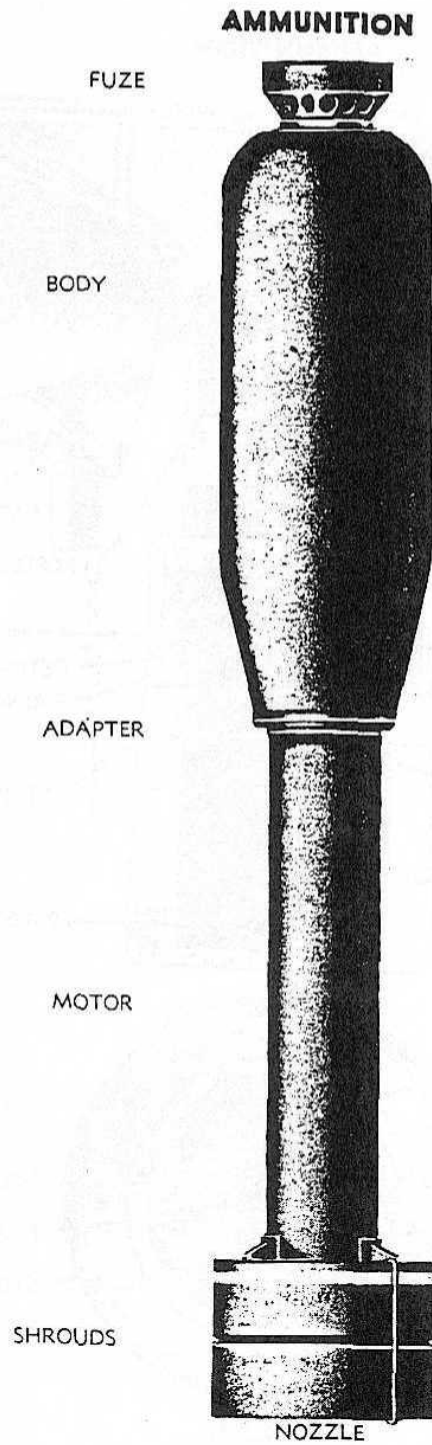

RA PD 89482

Figure 62—4.5-inch BR Rocket

AMMUNITION

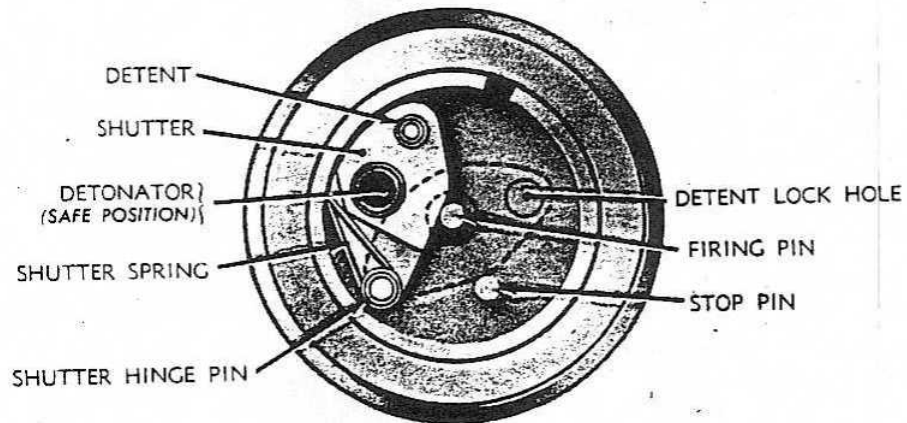
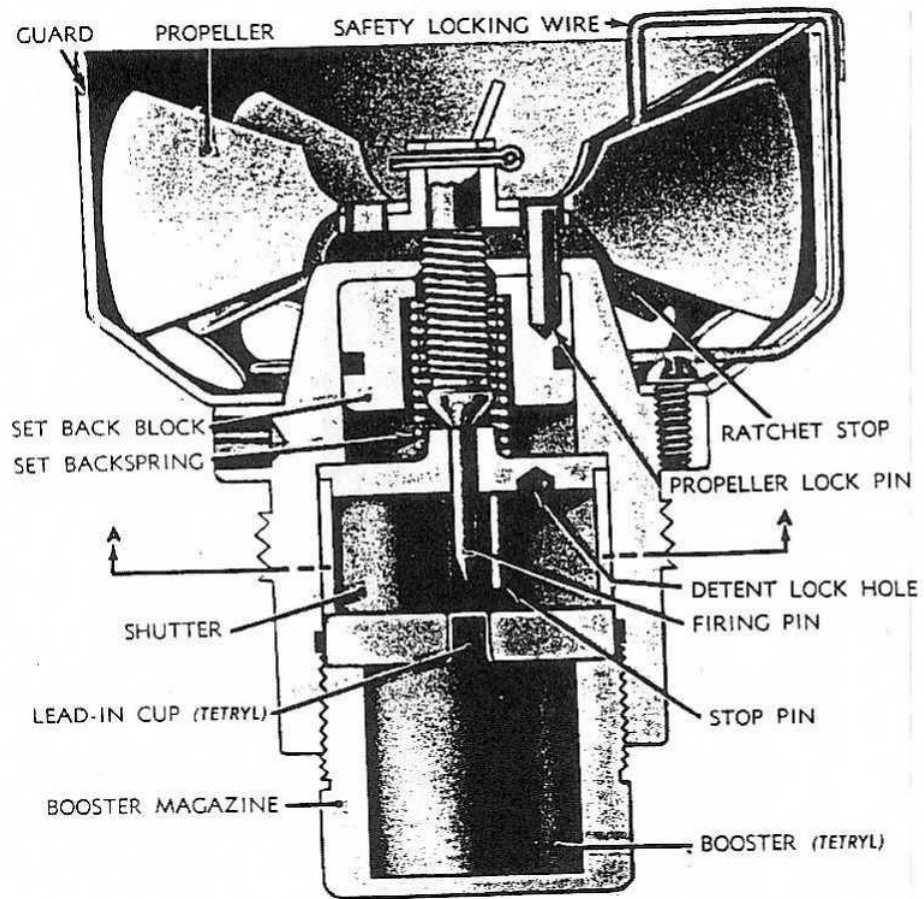

SECTION A-A

RA PD 89485

Figure 64—Fuze Mk. 137

TM 9-394  
126

4.5-INCH ROCKET MATERIEL FOR GROUND USE

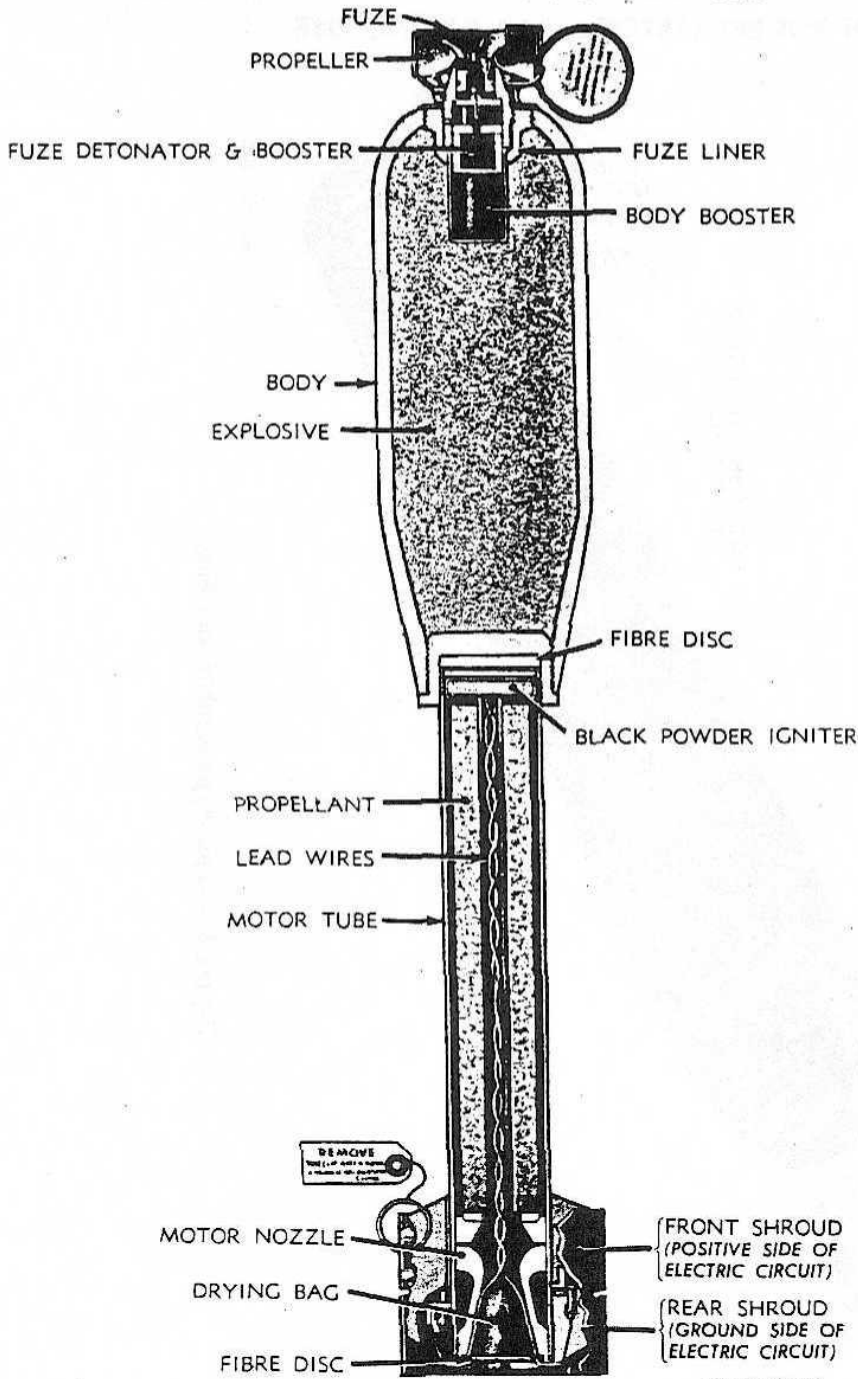
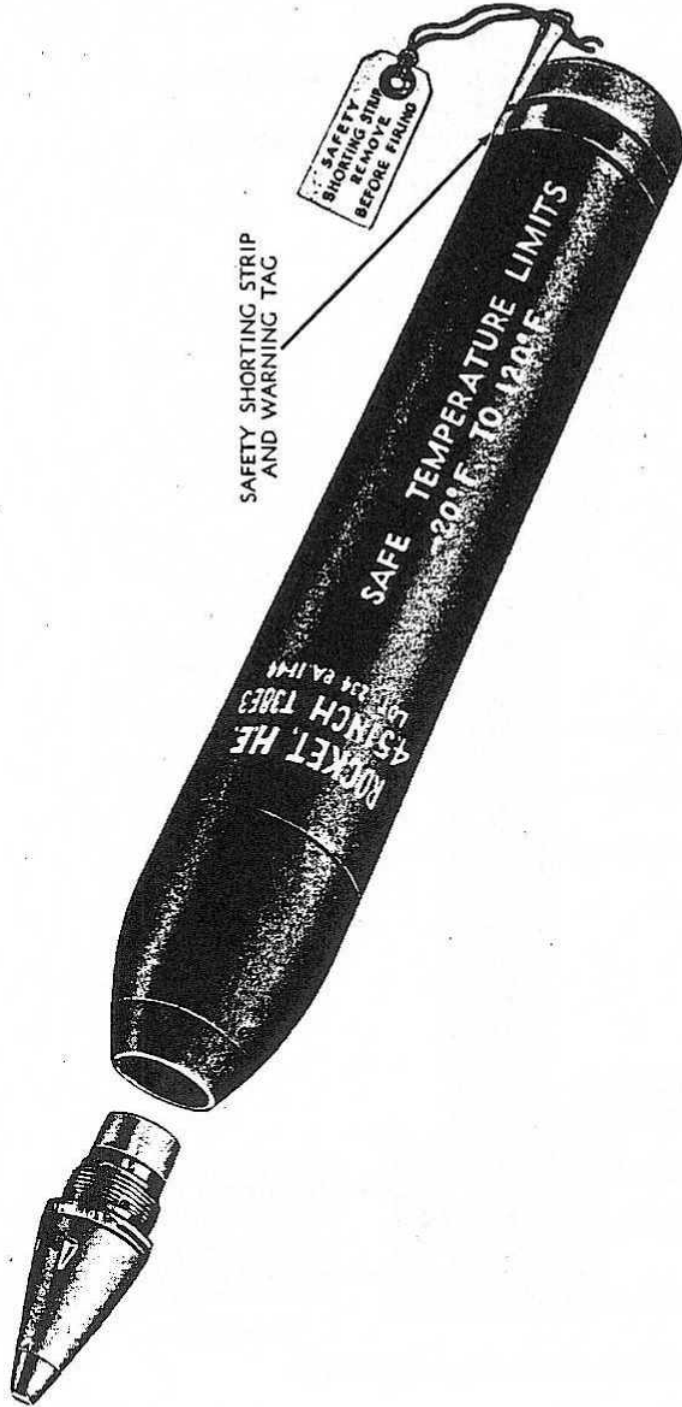

Figure 63—4.5-inch BR Rocket—Sectioned

TM 9-394  
126

4.5-INCH ROCKET MATERIEL FOR GROUND USE



RA PD 65209

Figure 65—Spin-type Rocket and Fuze

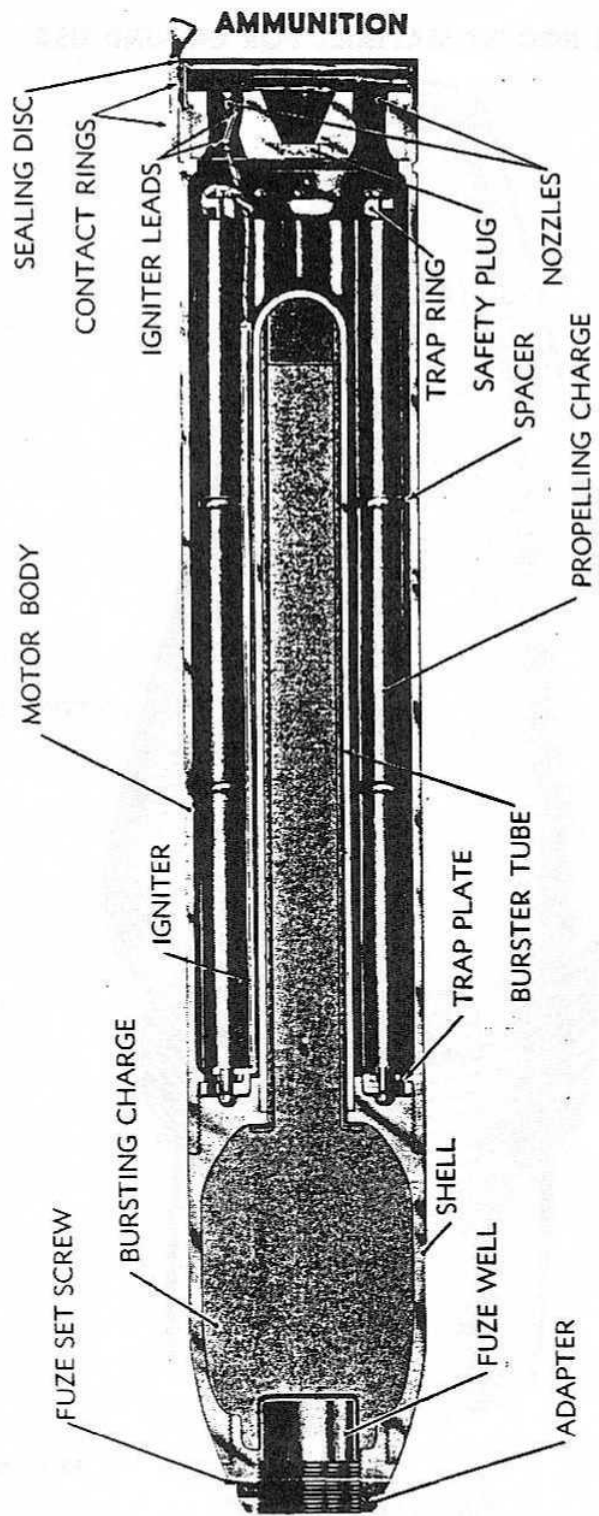

RA PD 65210

Figure 66—Spin-type Rocket Section

TM 9-394

126

4.5-INCH ROCKET MATERIEL FOR GROUND USE



RA PD 65211

Figure 67—Fuze M81

120



## AMMUNITION

c. **Motor.** The motor body is a steel tube closed at the base with a plug pierced by a circle of eight nozzles which are set at an angle to provide spin. A central vent is closed by a thin steel plate which is blown out if pressure exceeds safe limits. This type safety does not cause separation of the round as was the case with earlier types. The motor contains the propelling charge and igniter. The forward end is threaded for assembly to the rocket shell. The nozzle openings are protected by a plastic cap.

d. **Igniter.** The igniter (fig. 55) consists of a charge of black powder inclosed in a plastic tube attached to the trap and running the length of the charge. The tube also contains an electric squib. The leads of the squib pass through one of the nozzles; one lead is grounded to the motor body; the other is connected to a contact ring on the circumference of the plastic cap. In the case of rockets supplied with launcher of the M12 type (T38E7, T39E7) the leads are connected directly to the wire wound on the rear spacer.

### 127. FUZES FOR SPIN-STABILIZED ROCKETS.

a. **Type.** The fuze authorized for this type rocket is a selective SQ-0.05-second delay-type. The action may be selected at any time prior to firing by turning the setting sleeve in the side of the fuze (fig. 67). The head of the setting sleeve contains a slot which is parallel to the axis of the fuze when set superquick and at right angles to the axis for delay action. The fuze body is marked to indicate these positions.

b. **Models.** The fuze authorized for use with the Rocket M14 is the PD Fuze M81, w/Booster M24. Other models which are ballistically and tactically interchangeable are the fuzes of the M51 series with boosters of the M20 or M21 series and fuzes of the M48 series assembled to boosters of the M20 or M21 series. The fuze action of all these models is the same. They differ in that the Fuzes M51 have the booster assembled to the fuze, as issued, while the Fuzes M48 ordinarily are issued separately for assembly to a shell that already contains the booster. Some models of boosters have a safety cotter pin assembled to keep the booster from arming in handling and shipping. In other models, a set back pin serves this purpose. When the safety cotter pin is present, it must be removed prior to assembly of the fuze to the rocket. Besides this, setting the fuze for the desired action SQ or delay is the only preparation necessary for firing.

c. **Dummy Fuze.** The Dummy Fuze M73 is provided for use with practice rounds of spin-stabilized rockets. The fuze is a block of metal or plastic of the same shape and weight as the service fuze.

**4.5-INCH ROCKET MATERIEL FOR GROUND USE**

**128. PREPARATIONS FOR FIRING.**

a. To prepare the rocket for firing, the following steps should be taken:

(1) Remove the rocket from its packing and inspect for serviceability. Be sure that the base cap is firmly in place, and that the rocket motor body is not seriously dented. Make certain that the temperature range specified for the charge covers the expected temperature at firing.

(2) Fuze the rocket as follows:

(a) Unpack the fuze and inspect it for corrosion and other evidence of unserviceability.

(b) Set the fuze for the desired action.

(c) Loosen the set screw in the adapter of the rocket and remove the shell plug. Examine the fuze well cup to be sure that it is free of foreign material.

(d) Remove safety cotter pin from booster (par. 127).

(e) Screw the fuze into the rocket and tighten with fuze wrench.

(f) Tighten set screw.

(3) Load the rocket into the launcher in accordance with directions pertinent to the particular launcher.

(4) If the rocket is not used, unfuze by reversing the above step, and return to storage.

**129. PRECAUTIONS.**

a. The propellant powder used in rockets is very sensitive to temperature. It is important that rockets not be fired at temperatures outside the stated limits, and that they be protected in storage and transit against sources of high temperature such as the direct rays of the sun.

b. When a rocket is fired, the blast of flame extends to the rear approximately 75 feet. Personnel and materiel should be kept clear of this area from the time the launcher is loaded until after the rocket is fired. If practicable, inflammable material such as dry vegetation should be cleared from this area before firing.

c. When the propelling charge of the Rockets M8 or M9 is changed to the high-temperature range, the rockets must be marked to indicate the change. If the rockets are repacked, the containers also must be marked. The charge may be restored to the low-temperature range only if the sticks removed can be identified and returned to the same rocket.

**FIRE CONTROL EQUIPMENT FOR THE 4.5-INCH MULTIPLE  
ROCKET LAUNCHERS T27, T27E1 AND THE 4.5-INCH  
AUTOMATIC ROCKET LAUNCHER T45**

d. Igniter or base caps must be securely in place. If an igniter is loose, it should be pressed firmly and evenly into the rocket nozzle. If necessary, the igniter should be recemented in place.

e. Fuzes with broken or missing shear wires should be destroyed as ammunition in dangerous condition.

f. Rockets with dented motor bodies, bent fins, or like defects should not be used if such defects can not be repaired in the field.

---

**Section XXIX**

**FIRE CONTROL EQUIPMENT FOR THE 4.5-INCH  
MULTIPLE ROCKET LAUNCHERS T27, T27E1, AND  
THE 4.5-INCH AUTOMATIC ROCKET LAUNCHER T45**

**130. GENERAL.**

a. This section contains information on the arrangement of the sighting and fire control equipment. It includes instructions for operation, and maintenance of each item of on-carriage equipment, and instructions for bore sighting. It does not include instructions for use of off-carriage equipment, since these instructions are available in other Technical Manuals.

**131. ARRANGEMENT AND USE.**

a. **4.5-inch Multiple Rocket Launcher T27 or T27E1.** The sighting equipment for the 4.5-in. Multiple Rocket Launcher T27 or T27E1 includes the Telescope Mount T100, Telescope M6, and the Gunner's Quadrant M1.

b. **4.5-inch Automatic Rocket Launcher T45.** The Gunner's Quadrant M1 is furnished with the Automatic Rocket Launcher T45.

c. **Telescope Mount T100.** The Telescope Mount T100 supports the telescope in a front and rear seat (fig. 68). The mount is provided with elevating mechanism for keeping the target in the field of view while laying the launcher in azimuth. Mechanism for adjusting the line of sighting of the telescope in azimuth parallel to the bore of the launcher tubes is contained in the mount.

d. **Telescope M6.** The Telescope M6 (fig. 69) is used for laying the launcher in azimuth for direct fire.

e. **Gunner's Quadrant M1.** The Gunner's Quadrant M1 is used for laying the 4.5-inch Multiple Rocket Launcher T27, T27E1, and

4.5-INCH ROCKET MATERIEL FOR GROUND USE

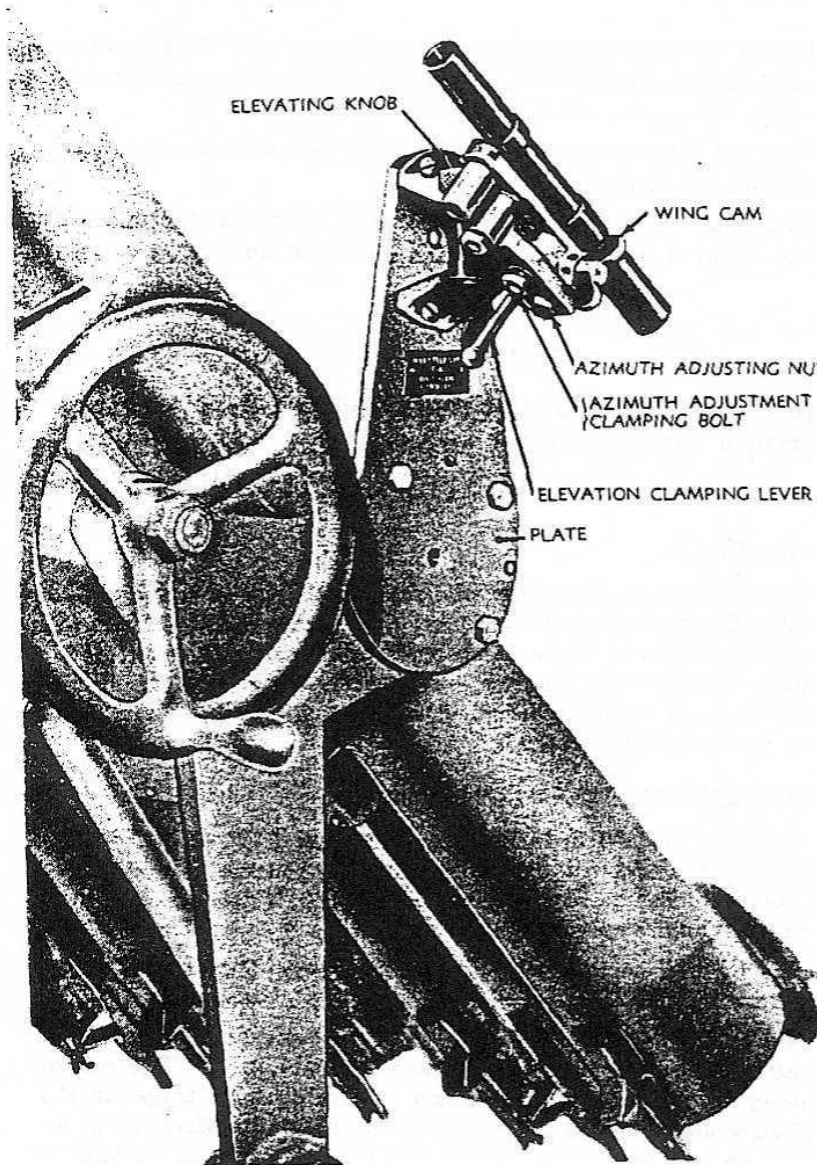

RA PD 60706

Figure 68—Telescope Mount T100 and Telescope M6 Assembled to the 4.5-inch Multiple Rocket Launcher T27

**FIRE CONTROL EQUIPMENT FOR THE 4-5-INCH MULTIPLE  
ROCKET LAUNCHERS T27, T27E1 AND THE 4.5-INCH  
AUTOMATIC ROCKET LAUNCHER T45**

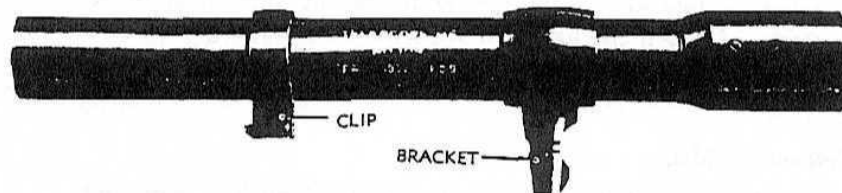

RA PD 43071

**Figure 69—Telescope M6**

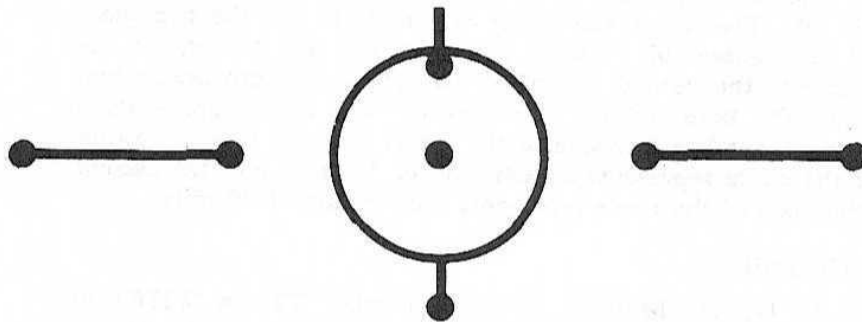

RA PD 60740

**Figure 70—Reticle Pattern of Telescope M6**

the 4.5-inch Automatic Rocket Launcher T45 in elevation. Instructions for use of the gunner's quadrant are contained in TM 9-575.

**132. TELESCOPE MOUNT T100 WITH TELESCOPE M6.**

**a. Telescope Mount T100.**

(1) The wing cam (fig. 68) secures the telescope in position on the mount. Turn the wing cam clockwise to clear the entrance for the bracket of the telescope when installing or removing the telescope. Turn the wing cam counterclockwise to engage the bracket and lock the telescope in position.

(2) The elevating knob is the knurled edge knob on the top of the adapter to the right of the telescope (fig. 68). It is used to elevate or depress the telescope in order to keep the image of the target in the field of view when laying the launcher in azimuth. An elevation clamping lever on the rear of the mount is moved sidewise to clamp the holder in the desired elevation.

**4.5-INCH ROCKET MATERIEL FOR GROUND USE**

(3) The azimuth adjustment clamping bolt (fig. 68) is used to clamp the bore sighting adjustment.

(4) The azimuth adjusting nut (fig. 68) is used to shift the rear of the holder laterally and thereby move the line of sighting of the telescope. Loosen the azimuth adjustment clamping bolt, and turn the azimuth adjusting nut in the desired direction. Tighten the clamping bolt.

**h. Telescope M6.**

(1) The Telescope M6 (fig. 69) is provided with a clip and bracket for positioning the telescope in the holder of the mount. The telescope is a one-power instrument having a field of view of 11 degrees.

(2) The reticle pattern as seen through the telescope is shown in figure 70. The dot in the center of the circle and the two short vertical lines extending outward from the top and bottom of the circle indicate the vertical center of the reticle, and are used when performing the bore sighting adjustment. The circle represents a deflection of 5 mils either side of the center dot, the first dot either side of the circle represents a deflection of 10 mils, and the second dot either side of the circle represents a deflection of 20 mils.

**c. Operation.**

(1) To lay the Multiple Rocket Launcher T27 or T27E1 in azimuth, sight through the telescope and bring the target into the field of view by means of the elevating knob and the shifting of the complete launcher in azimuth. Keep the target near the center of the field of view with the elevating knob so that the launcher can be shifted until the target appears at the desired deflection.

(2) To lay the Automatic Rocket Launcher T45 in azimuth, shift the complete launcher, or if mounted on a vehicle shift the vehicle until the launcher points towards the target.

(3) To lay the Multiple Rocket Launcher T27 or T27E1 in elevation, set the desired elevation on the Gunner's Quadrant M1 and place the quadrant on one of the launcher tubes. Elevate the launcher tube with the elevating handwheel until the level bubble on the gunner's quadrant is centered with respect to the graduations on the level vial. Remove the gunner's quadrant before firing.

(4) To lay the Automatic Rocket Launcher T45 in elevation, first remove the adjustment nuts and bolts on the crutch assembly (fig. 36) so the launcher can be elevated or depressed. Support the forward end of the launcher while removing the adjustment nuts and bolts. Set the desired elevation on the gunner's quadrant and



**FIRE CONTROL EQUIPMENT FOR THE 4-5-INCH MULTIPLE  
ROCKET LAUNCHERS T27, T27E1 AND THE 4.5-INCH  
AUTOMATIC ROCKET LAUNCHER T45**

place the quadrant on the launching rail. Raise or lower the forward end of the launcher until the level bubble in the gunner's quadrant is centered. Replace the adjustment bolts through the crutch and secure them with the nuts. If the holes in the crutch do not aline perfectly for the adjustment bolts, elevate or depress the launcher to the nearest set of holes which will aline and insert the bolts. Remove the gunner's quadrant before firing.

d. **Adjustments.** No adjustment of the sighting and fire control equipment by the using arm other than the bore sighting adjustment described in paragraph 133 is authorized.

e. **Care.**

(1) **AUTHORIZED CLEANING MATERIALS.**

ALCOHOL, ethyl, grade 1 (for optical parts)

BRUSH, artist, camel's-hair rd. (for optical parts)

CLOTH, wiping, cotton (for metal parts)

PAPER, lens, tissue (for lens cleaning)

SOAP, liquid, lens cleaning (for cleaning lenses)

(2) **AUTHORIZED LUBRICANT** is lubricating oil, for aircraft instruments and machine guns.

(3) **TELESCOPE MOUNT T100.**

(a) Keep the telescope mount clean. Wipe off all excess lubricant which may have seeped from the interior of the working parts.

(b) Keep the locating surfaces of the mount coated with a light film of lubricating oil to prevent rust.

(c) Keep the telescope mount covered when not in use, to prevent the accumulation of dust and grit on the locating surfaces.

(d) See that the clamping bolt on the under side of the support (center bolt) and the nuts which secure the plate to the sight bracket are kept tight.

(4) **TELESCOPE M6.**

(a) When the telescope is not in use, keep it in the box which is provided. When the exposed optical surfaces become dusty or dirty, clean with a camel's-hair brush or with a tuft of lens tissue paper and ethyl alcohol, or liquid lens cleaning soap. If the alcohol or soap is not available, and if temperature is above freezing, breathe heavily on the surface and wipe gently with a clean piece of lens tissue paper.

(b) Wipe all dust and grit from the clip and bracket of the telescope with a piece of clean cotton cloth before installing the telescope in the mount.

(c) Be careful not to nick or bur any of the locating surfaces, especially when installing the telescope in the mount.



**4.5-INCH ROCKET MATERIEL FOR GROUND USE**

**133. BORE SIGHTING.**

a. In the case of the Multiple Rocket Launcher T27 or T27E1, the bore sighting is performed in order to adjust the line of sighting to the Telescope M6 laterally parallel to the bore of the launcher tubes. Vertical parallelism is not required as the telescope mount and telescope have no scale or level bubble. The bore sighting adjustment should be made whenever a new telescope mount is installed on the launcher, and the adjustment should be verified occasionally. To perform the bore sighting adjustment proceed as follows:

(1) Select a clearly defined aiming point 500 to 1000 yards distant from the launcher.

(2) Stretch two strings across the bore of the launcher tube nearest to the telescope; one pair of strings at the muzzle and the other at the breech. Arrange each pair of strings so that they intersect at the center of the bore, thereby establishing a line of sight through the center of the bore. Secure the strings to the launcher tube with tape or a rubber band or any other suitable material. Look through the bore and aline the center line with the distant aiming point.

(3) Loosen the elevation clamping lever on the telescope mount and elevate or depress the line of sighting of the telescope with the elevating knob until the aiming point appears in the field of view. *If the aiming point alines with the center dot, or short vertical lines on the reticle pattern, the telescope is in adjustment, and nothing further is required.*

(4) *If the aiming point appears either side of the center dot or vertical line, loosen the azimuth adjustment clamping bolt (center bolt on under side of mount), and then turn the azimuth adjusting nut (rear nut on under side of mount) until alinement is obtained. Tighten the clamping bolt, and check the alinement to see that the vertical center of the reticle has not slipped off the aiming point.*

APPENDIX

Section XXX

STORAGE AND SHIPMENT

134. GENERAL.

a. The preparation of rocket launchers for domestic shipment and limited storage will be the same. Special precautions must be taken to prevent corrosion of the materiel during these periods.

b. The tubes and metal parts should be protected by observing normal precautions, such as covering the launchers with tarpaulins while stowed, or storing under a roof where possible.

135. CLEANING, PAINTING, AND PRESERVATIVE TREATMENT.

a. **Cleaning.** Materiel shall be thoroughly cleaned; use dry-cleaning solvent or a soap solution.

(1) SOLVENT METHOD.

(a) Apply dry-cleaning solvent with a clean brush or cloth. Repeat applications with clean solvent, until all traces of foreign matter have been removed.

(b) To protect hands from inflammation, use synthetic rubber gloves or hand protective creams. (Solvent is toxic to some persons.)

(c) Dry surfaces thoroughly with clean dry cloths. Do not touch cleaned surfaces with bare hands.

(2) SOAP SOLUTION METHOD.

(a) Prepare soap solution as follows: Add shavings of issue soap to water, in the proportion of 1 pound of soap to 4 gallons of water. Heat the water until the soap is dissolved, stirring the water slowly to prevent foaming.

(b) Apply soap solution by vigorously brushing or scrubbing the surfaces thoroughly until all traces of foreign matter have been removed.

(c) Rinse surfaces thoroughly with clean hot water to remove soap, and immediately dry as specified in paragraph a (1) (c), above.

b. **Removing Rust Spots.** Painted or coated surfaces that have become checked, chipped, pitted, or rusted should be cleaned with aluminum-oxide abrasive cloth or crocus cloth.

c. **Painting.**

(1) After rust spots have been removed as described in b above, thoroughly clean parts to be repainted.

**TM 9-394**

**135-136**

**4.5-INCH ROCKET MATERIEL FOR GROUND USE**

(2) Apply a liberal coating of rust-inhibitive synthetic primer over the entire area of the cleaned bare surfaces by brushing or spraying.

(3) Sandpaper the primed surfaces with class B, No. 2/0 flint paper and wipe all particles of dust from surfaces.

(4) Apply coat of O.D. lustreless synthetic enamel and allow to dry thoroughly.

**d. Application of Preservatives.**

(1) **EXTERIOR UNPAINTED SURFACES.** Apply a coating of rust preventive compound (light) to all exterior unpainted surfaces.

(2) **INTERIOR OF STEEL TUBES.** Coat the interior of the steel tubes with rust-preventive compound (light).

**e. Removal of Preservatives.** Remove the rust-preventive compounds applied to surfaces by thoroughly cleaning with dry-cleaning solvent. Dry thoroughly before oiling.

**136. LIMITED STORAGE INSPECTION.**

**a.** A visual inspection shall be made weekly during the storage to determine general condition. If corrosion is found on any part, remove the rust spots, clean and repaint, and treat with the prescribed preservative.

Section XXXI

REFERENCES

137. PUBLICATIONS INDEXES.

The following publications indexes should be consulted frequently for latest changes or revisions of references given in this section and for new publications relating to materiel covered in this manual:

- a. Ordnance supply catalog index (index to SNL's) ..... ASF Cat.  
ORD 2 OPSI
- b. Major items and combinations, and pertinent publications ..... SB 9-1
- c. List of publications for training (listing CCBP's, FM's, FT's, MTP's, TB's, TM's, TR's, TC's, and WDLO's) ..... FM 21-6
- d. List of training films, film strips, and film bulletins ..... FM 21-7
- e. Military training aids (listing graphic training aids, models, devices, and displays) ..... FM 21-8
- f. List of administrative and supply publications (listing MR's, RR's, SB's, WDMWO's, and WDP's) ..... WD Pamphlet  
12-6

138. STANDARD NOMENCLATURE LISTS.

- a. Cleaning, preserving and lubricating materials; recoil fluids, special oils and miscellaneous related items ..... SNL K-1
- b. Launchers ..... SNL C-67
- c. Quadrant, gunner's, M1 ..... SNL F-140
- d. Rockets, all types, and components ..... ORD 11 SNL S-9
- e. Telescope, M6 ..... SNL F-184

139. EXPLANATORY PUBLICATIONS.

- a. Ammunition.
  - Ammunition, general ..... TM 9-1900  
WDSB 9-AMM1
  - Ammunition condition report ..... O.O. 7235
  - Ammunition identification code ..... WDSB 9-AMM5

**4.5-INCH ROCKET MATERIEL FOR GROUND USE**

- Ammunition inspection guide..... TM 9-1904
- 4.5" aircraft rocket materiel..... TM 9-395
- Ordnance safety manual..... O.O. 7224
- Qualification in arms and ammunition for training allowances ..... AR 775-10
- Range regulations for firing ammunition for training and target practice..... AR 750-10
- Unsafe ammunition ..... WDSB 9-AMM2
- b. Cleaning, preserving, sealing, lubricating, and related materials issued for ordnance materiel ..... TM 9-850
- c. Fire Control.
  - Auxiliary fire control instruments (field glasses, eyeglasses, telescopes and watches) ..... TM 9-575
- d. Storage and Shipment.
  - Catalog of approved packaging instructions for major items and spare parts for ordnance general supplies..... PS No. 1000
  - Ordnance packaging and shipping manual for field use (posts, camps, and stations).. TM 9-2854
  - Ordnance storage and shipment charts..... SB 9-OSSC-C
- e. Decontamination ..... TM 3-220
- f. Defense against chemical attack..... FM 21-40

INDEX

A	Page	D	Page
Ammunition		Crutch assembly.....	99
classification .....	101		
completed rounds.....	103, 114	<b>D</b>	
data .....	103	Drivers' shield assembly.....	90
description			
auxiliary booster.....	112	<b>E</b>	
fin-stabilized rockets		Electrical connections.....	35
Army-type .....	111	Elevating handwheel, operation ..	22
Navy-type .....	113	Elevating mechanism	
fuzes .....	111, 113, 121	(T27 and T27E1).....	82
propelling charge .....	107	Elevating strut, maintenance.....	86
identification .....	102	Elevation clamping lever.....	128
modification of fin-type rocket.....	107	Emplacement for firing launchers	
stabilization and filler.....	101	M12, M12A1, and M12E2.....	33
(See also Shell, rocket; Fuzes, and Motor)		T27 .....	38
Amphibian truck.....	88	T27E1 .....	41
Auxiliary booster.....	112	T45 .....	58
Auxiliary equipment.....	101	Equipment	
		auxiliary .....	101
<b>B</b>		sighting and fire control .....	123
Base frame, crutch assembly.....	99	Exactor transmitters.....	23
Battery, two-cell, description.....	19	Exploder, ten-cap.....	20
Blasting machine .....	20		
Bore sighting .....	128	<b>F</b>	
		Field report of accidents.....	2
<b>C</b>		Fire control equipment	
Cable, firing .....	96	adjustment .....	127
Cable support .....	94	arrangement and use.....	123
Cautions, loading .....	45	care .....	127
Components of ammunition.....	103	operation .....	126
Contact assemblies (See Tube groups)		Firing	
Contact box .....	95	precautions prior to firing.....	56
Controls		to fire single rockets or a salvo ..	37
maintenance of firing controls ..	88	(See also under Launchers, rocket)	
operation on launchers		Firing button, operation.....	23, 28
M12, M12A1, and M12E2 .....	19	Firing cable .....	96
T27 and T27E1 .....	20	Firing control box.....	91, 99
T34 and T34E1.....	23	Firing controls, maintenance... ..	82, 88
T44 .....	26	Firing mechanism .....	90
T45 .....	27	Firing pilot light.....	29
Cradle assembly (T27 and T27E1)	81		
Cross beams .....	90, 93		

4.5-INCH ROCKET MATERIEL FOR GROUND USE

F—Contd.	Page	Page
<b>Fuzes</b>		<b>Landing vehicle (tracked (A) (4))</b> . . . . . 93
arming . . . . .	112	<b>Launcher body assembly</b> . . . . . 94
authorized for use with HE		<b>Launchers, rocket</b>
round . . . . .	113	data
dummy . . . . .	112, 121	M12, M12A1, and M12E2 . . . . . 4
inspection prior to use . . . . .	114	T27 and T27E1 (multiple) . . . . . 12
setting . . . . .	111	T34 and T34E1 . . . . . 15
used with:		T44 (multiple) . . . . . 15
fin-stabilized rockets		T45 . . . . . 16
Army-type . . . . .	111	demolition
Navy-type . . . . .	113	all launchers . . . . . 67
spin-stabilized rockets . . . . .	121	general discussion . . . . . 66
		description
<b>G</b>		M12, M12A1, and M12E2 . . . . . 2
Gate assembly . . . . .	95	T27, T27E1, and T44 (multiple) . . . . . 3
Gunner's quadrant M1 . . . . .	123	T34 and T34E1 . . . . . 3
		T45 (automatic) . . . . . 4
<b>H</b>		emplacement
Hand generator . . . . .	84	M12, M12A1, and M12E2 . . . . . 33
		T27 . . . . . 38
<b>I</b>		T27E1 . . . . . 41
Igniters, description . . . . .	107, 121	T45 . . . . . 48
Indicator, selector switch, operation on launchers		firing
T27 and T27E1 . . . . .	22	M12, M12A1, and M12E2 . . . . . 37
T34 and T34E1 . . . . .	25	T27 and T27E1 . . . . . 45
T44 . . . . .	26	T34 and T34E1 . . . . . 49
Instruments, operation on launchers		T44 . . . . . 57
T27- and T27E1 . . . . .	20	T45 . . . . . 63
T34 and T34E1 . . . . .	25	jettisoning . . . . . 54
T44 . . . . .	26	loading
T45 . . . . .	29	T27 and T27E1 . . . . . 45
		T34 and T34E1 . . . . . 49
<b>J</b>		T44 . . . . . 55
Junction box . . . . .	100	T45 . . . . . 60, 61
		maintenance . . . . . 68
<b>K</b>		malfunctions and corrections . . . . . 71
Keys, safe and reset, operation		misfires
T27 and T27E1 . . . . .	22	M12, M12A1, and M12E2 . . . . . 38
T34 and T34E1 . . . . .	23	T27 and T27E1 . . . . . 48
		T34 and T34E1 . . . . . 54
<b>L</b>		T44 . . . . . 58
"L" supports . . . . .	94	T45 . . . . . 64



INDEX

L—Contd.	Page	Page
Launchers, rocket—Contd.		Preservatives, application . . . . . 19
operation		Propelling charge, description . . . 107
M12, M12A1, and M12E2 . . . 29		
T27 and T27E1 . . . . . 38		<b>R</b>
T34 and T34E1 . . . . . 49		Reel assembly . . . . . 95
T44 . . . . . 55		Register assembly . . . . . 94
T45 . . . . . 58		Release assembly . . . . . 81
under unusual conditions . . . 65		Reports and records . . . . . 2
service upon receipt of equip-		Reset key (See Keys)
ment		Rockets, fin-stabilized (Army-type)
M12, M12A1, and M12E2 . . . 17		data . . . . . 103
T27, T27E1, T34, and		description of fuzes . . . . . 111
T34E1 . . . . . 18		modifications . . . . . 107
T44 and T45 . . . . . 19		preparation for firing . . . . . 112
unloading . . . . . 48, 58, 64		Rockets, fin stabilized (Navy-type)
Lights . . . . . 22		description of fuzes and rockets 113
Loading (See Launchers, rocket)		inspection . . . . . 114
		preparations for firing and pre-
<b>M</b>		cautions . . . . . 122
Maintenance, preventive . . . . . 68		Rockets, spin-stabilized
Master power switch (See Switches)		data and shells used . . . . . 114
Model numbers . . . . . 102		fuzes used and operation of
Motors		motor and igniter . . . . . 121
description		Rod assemblies . . . . . 94
fin-stabilized rocket . . . . . 103, 113		
spin-stabilized rocket . . . . . 121		<b>S</b>
inspection . . . . . 114		Safe key (See Keys)
Mount assembly . . . . . 81		Safety plugs . . . . . 26, 27
		Salvos, emplacement for firing . . . 23
<b>N</b>		Selector switch indicator . . . . . 22
Nomenclature, standard . . . . . 102		Shells, rocket
		description . . . . . 103
<b>O</b>		used for:
Operation under:		fin-stabilized rockets . . . . . 103
unusual conditions . . . . . 65		spin-stabilized rockets . . . . . 114
usual conditions . . . . . 29		Sighting equipment . . . . . 123, 127
		Signal light
<b>P</b>		operation in launchers
Painting ammunition . . . . . 102		T27 and T27E1 . . . . . 22
Periscope block . . . . . 86		T34 and T34E1 . . . . . 25
Power button, operation . . . . . 28		Spacer tubes . . . . . 77
Precautions . . . . . 122		Spreader . . . . . 94

